



電磁相容試驗報告

世騰電子科技股份有限公司測試實驗室

標準檢驗局指定實驗室認可編號(SL2-IN/R1/R2-E-0054)

申請廠商 : 泓澤檢測設備股份有限公司

地址 : 新北市三重區集智街 62 號

產品名稱 : 電源供應器

主型號 : GTM46161-155.0-USB

系列型號 : 詳見 1.1 章節

檢驗標準 : CNS 15936 (乙類設備)

試驗結果 : 合格

實驗室報告號碼: 24010161-TETE01

案件受理日期: 113 年 01 月 18 日

報告發行日期: 113 年 02 月 07 日



目 錄

證 明 書	3
1. 一般描述	4
1.1. 待測設備樣品/特性/差異說明	4
1.2. 測試軟體及測試模式	5
1.3. 受測裝置之系統說明	7
1.4. 測試週邊配置圖	7
2. 測試情形之描述	8
2.1. 測試場地	8
2.2. 測試電壓	8
2.3. 量測方法之法規	8
2.4. 測試依據法規	8
2.5. 量測頻率範圍	8
2.6. 量測距離	8
2.7. 量測不確定度	8
3. 電源線與異對稱模式之傳導擾動之量測規定	9
3.1. 電源線與異對稱模式之傳導擾動之量測規定	9
3.2. 異對稱模式之傳導擾動	10
3.3. 測試擺設圖	11
3.4. 測試儀器	11
3.5. 電源端之傳導干擾測試結果及數據	12
3.6. 異對稱模式測試結果及數據	16
3.7. 電源端之傳導干擾配置照片	17
4. 差模傳導電壓放射量測	18
4.1. 適用標準	18
4.2. 測試程序	18
4.3. 測試擺設圖	19
4.4. 測試結果及數據	19
5. 輻射干擾場強之量測	20
5.1. 適用標準	20
5.2. 測試程序	21
5.3. 測試擺設圖	21
5.4. 測試儀器	23
5.5. 測試結果及數據 (30MHz ~ 1GHz)	24
5.6. 輻射量測之配置照片 (30MHz ~ 1GHz)	28
6. FM 接收機之輻射放射之量測	29
6.1. 適用標準	29
6.2. 測試結果及數據	29
7. 抑制元件及干擾源一覽表	30
7.1. 抑制元件	30
7.2. 干擾源	30
附錄 A: 產品照	A1 ~ A60



證明書

CNS 15936 乙類

申請廠商 : 泓澤檢測設備股份有限公司

地址 : 新北市三重區集智街 62 號

產品名稱 : 電源供應器

主型號 : GTM46161-155.0-USB

系列型號 : 詳見 1.1 章節

該產品樣品試

驗依據之試驗
標準

CNS 15936 乙類

規範修訂日期:本試驗報告所列之量測皆依據 CNS 15936: 2016 年版之規定來執行。

茲在此鄭重聲明：

本試驗報告所列之待測設備樣品已於民國 113 年 01 月 24 日~ 113 年 01 月 25 日在本公司的標準測試場地完成詳細及完整之量測。並判斷此待測設備樣品確實符合 CNS 15936 乙類中所規定之各測試項目限制值。

備註：本測試報告僅對受測之樣品負責。非經本公司同意，測試報告不得摘錄複印使用。(全部複製除外)。

電源/異對稱/差模傳導干擾測試場地編號: CON01-NK

輻射干擾測試場地編號: 10M01-NK ; FM 接收機之輻射測試場地編號: 3M01-NK

實驗室認可證書有效期限：115 年 07 月 08 日

實驗室認可編號及範圍：1439 (9 kHz to 40 GHz)

特據此證明！

測試項目	檢驗儀器	檢驗結果	結果判定
電源傳導干擾之量測	請參閱 3.4 節	請參閱 3.5 節	合格
異對稱模式之傳導擾動量測	免驗	免驗	免驗
輻射干擾場強之量測	請參閱 5.4 節	請參閱 5.5 節	合格
FM 接收機之輻射量測	免驗	免驗	免驗
差模傳導電壓放射量測	免驗	免驗	免驗

本實驗室已依據合約內的標準，降低儀器、環境、人員等不確定因素，因此測試結果將直接依照標準要求判定之，均不納入量測不確定度評估。





報告簽署人：



1. 一般描述

1.1. 待測設備樣品/特性/差異說明

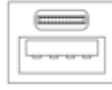
型號間差異只在於型號名稱,輸出電壓電流,輸出端類型&數量、PCB Layout 以及二次側部分零件規格不同,其他皆相同,具體詳見如下表格。

NO.	Model	Output voltage(V)	Output current(A)	output power(W)	Tranformer	Transformer model	Remark	layout (main board)	layout (small board)
1	GTM46161-155.0-USB	5	3	15	GlobTek/ENG	XF01036	USB*1 	#8	N/A
2	GTM46161-155.2-USB	5.2	2.88	15	GlobTek/ENG	XF01036			
3	GTM46161-165.0-USB	5	3.2	16	GlobTek/ENG	XF01036			
4	GTM46161-165.2-USB	5.2	3.07	16	GlobTek/ENG	XF01036			
5	GTM46161-165.3-USB	5.3	3.01	16	GlobTek/ENG	XF01036			
6	GTM46161-165.4-USB	5.4	2.96	16	GlobTek/ENG	XF01036			
7	GTM46161-165.5-USB	5.5	2.9	16	GlobTek/ENG	XF01036			
8	GTM46161-105.2-USB1A	5.2	1.92	10	GlobTek/ENG	XF01036			
9	GTM46161-115.2-USB1A	5.2	2.1	11	GlobTek/ENG	XF01036			
10	GTM46161-135.2-USB1A	5.2	2.5	13	GlobTek/ENG	XF01036			
11	GTM46161-155.0-USB1A	5	3	15	GlobTek/ENG	XF01036			
12	GTM46161-155.2-USB1A	5.2	2.88	15	GlobTek/ENG	XF01036			
13	GTM46161-165.0-USB1A	5	3.2	16	GlobTek/ENG	XF01036			
14	GTM46161-165.2-USB1A	5.2	3.07	16	GlobTek/ENG	XF01036			
15	GTM46161-165.5-USB1A	5.5	2.9	16	GlobTek/ENG	XF01036			
16	GTM46161-155.0-USB2A	5	3	15	GlobTek/ENG	XF01036			
17	GTM46161-155.2-USB2A	5.2	2.88	15	GlobTek/ENG	XF01036			
18	GTM46161-165.0-USB2A	5	3.2	16	GlobTek/ENG	XF01036			
19	GTM46161-165.2-USB2A	5.2	3.07	16	GlobTek/ENG	XF01036			
20	GTM46161-165.5-USB2A	5.5	2.9	16	GlobTek/ENG	XF01036			
21	GTM46161-115.0-USBC	5	2.2	11	GlobTek/ENG	Type C 	#3	#4	
22	GTM46161-155.0-USBC	5	3	15	GlobTek/ENG				XF01036
23	GTM46161-155.2-USBC	5.2	2.88	15	GlobTek/ENG				XF01036
24	GTM46161-165.0-USBC	5	3.2	16	GlobTek/ENG				XF01036
25	GTM46161-165.2-USBC	5.2	3.07	16	GlobTek/ENG				XF01036
26	GTM46161-165.5-USBC	5.5	2.9	16	GlobTek/ENG				XF01036
27	GTM46161-155.0-USB1A1C	5	3	15	GlobTek/ENG	USB*1 and Type C*1 	#5	#6	
28	GTM46161-155.2-USB1A1C	5.2	2.88	15	GlobTek/ENG				XF01036
29	GTM46161-165.0-USB1A1C	5	3.2	16	GlobTek/ENG				XF01036
30	GTM46161-165.2-USB1A1C	5.2	3.07	16	GlobTek/ENG				XF01036
31	GTM46161-165.5-USB1A1C	5.5	2.9	16	GlobTek/ENG				XF01036
32	GTM46161-155.0-USB2C	5	3	15	GlobTek/ENG	Type C*2 	#7	#7	
33	GTM46161-155.2-USB2C	5.2	2.88	15	GlobTek/ENG				XF01036
34	GTM46161-165.0-USB2C	5	3.2	16	GlobTek/ENG				XF01036
35	GTM46161-165.2-USB2C	5.2	3.07	16	GlobTek/ENG				XF01036
36	GTM46161-165.5-USB2C	5.5	2.9	16	GlobTek/ENG				XF01036



1.2. 測試軟體及測試模式

- 測試軟體: 無。
- 本申請件之最高工作頻率為 95KHz 小於 108MHz, 故輻射干擾測試範圍為 30MHz ~ 1GHz。
- 本申請件測試模式如下:

傳導干擾測試	
Test Mode 1	Full Load for Type A (5V/3.2A) ,EUT:1
Test Mode 2	Full Load for Type A (5.5V/2.9A) ,EUT:2
Test Mode 3	Full Load for Type A (5V/3.2A) ,EUT:3
Test Mode 4	Full Load for Type A (5.5V/2.9A) ,EUT:4
Test Mode 5	Full Load for Type A1 (5V/3.2A) ,EUT:5
Test Mode 6	Full Load for Type A2 (5V/3.2A) ,EUT:5
Test Mode 7	Full Load for Type A1 (5V/1.6A) + Type A2 (5V/1.6A) ,EUT:5
Test Mode 8	Full Load for Type A1 (5.5V/2.9A) ,EUT:6
Test Mode 9	Full Load for Type A2 (5.5V/2.9A) ,EUT:6
Test Mode 10	Full Load for Type A1 (5.5V/1.45A) + Type A2 (5.5V/1.45A) ,EUT:6
Test Mode 11	Full Load for Type C (5V/3.2A) ,EUT:7
Test Mode 12	Full Load for Type C (5.5V/2.9A) ,EUT:8
Test Mode 13	Full Load for Type C (5V/3.2A) ,EUT:9
Test Mode 14	Full Load for Type A (5V/3.2A) ,EUT:9
Test Mode 15	Full Load for Type C (5V/1.6A) + Type A1 (5V/1.6A) ,EUT:9
Test Mode 16	Full Load for Type C (5.5V/2.9A) ,EUT:10
Test Mode 17	Full Load for Type A (5.5V/2.9A) ,EUT:10
Test Mode 18	Full Load for Type C (5.5V/1.45A) + Type A (5.5V/1.45A) ,EUT:10
Test Mode 19	Full Load for Type C1 (5V/3.2A) ,EUT:11
Test Mode 20	Full Load for Type C2 (5V/3.2A) ,EUT:11
Test Mode 21	Full Load for Type C1 (5V/1.6A) + Type C2 (5V/1.6A) ,EUT:11
Test Mode 22	Full Load for Type C1 (5.5V/2.9A) ,EUT:12
Test Mode 23	Full Load for Type C2 (5.5V/2.9A) ,EUT:12
Test Mode 24	Full Load for Type C1 (5.5V/1.45A) + Type C2 (5.5V/1.45A) ,EUT:12
Test Mode 25	Half Load for Type C1 (5.5V/0.725A) + Type C2 (5.5V/0.725A) ,EUT:12

經驗證以” Test Mode 24,25” 之測試結果為最差，以此作為發報告之依據。



輻射干擾測試	
Test Mode 1	Full Load for Type A (5V/3.2A) ,EUT:1
Test Mode 2	Full Load for Type A (5.5V/2.9A) ,EUT:2
Test Mode 3	Full Load for Type A (5V/3.2A) ,EUT:3
Test Mode 4	Full Load for Type A (5.5V/2.9A) ,EUT:4
Test Mode 5	Full Load for Type A1 (5V/3.2A) ,EUT:5
Test Mode 6	Full Load for Type A2 (5V/3.2A) ,EUT:5
Test Mode 7	Full Load for Type A1 (5V/1.6A) + Type A2 (5V/1.6A) ,EUT:5
Test Mode 8	Full Load for Type A1 (5.5V/2.9A) ,EUT:6
Test Mode 9	Full Load for Type A2 (5.5V/2.9A) ,EUT:6
Test Mode 10	Full Load for Type A1 (5.5V/1.45A) + Type A2 (5.5V/1.45A) ,EUT:6
Test Mode 11	Full Load for Type C (5V/3.2A) ,EUT:7
Test Mode 12	Full Load for Type C (5.5V/2.9A) ,EUT:8
Test Mode 13	Full Load for Type C (5V/3.2A) ,EUT:9
Test Mode 14	Full Load for Type A (5V/3.2A) ,EUT:9
Test Mode 15	Full Load for Type C (5V/1.6A) + Type A1 (5V/1.6A) ,EUT:9
Test Mode 16	Full Load for Type C (5.5V/2.9A) ,EUT:10
Test Mode 17	Full Load for Type A (5.5V/2.9A) ,EUT:10
Test Mode 18	Full Load for Type C (5.5V/1.45A) + Type A (5.5V/1.45A) ,EUT:10
Test Mode 19	Full Load for Type C1 (5V/3.2A) ,EUT:11
Test Mode 20	Full Load for Type C2 (5V/3.2A) ,EUT:11
Test Mode 21	Full Load for Type C1 (5V/1.6A) + Type C2 (5V/1.6A) ,EUT:11
Test Mode 22	Full Load for Type C1 (5.5V/2.9A) ,EUT:12
Test Mode 23	Full Load for Type C2 (5.5V/2.9A) ,EUT:12
Test Mode 24	Full Load for Type C1 (5.5V/1.45A) + Type C2 (5.5V/1.45A) ,EUT:12
Test Mode 25	Half Load for Type C1 (5.5V/0.725A) + Type C2 (5.5V/0.725A) ,EUT:12
經驗證以” Test Mode 24,25” 之測試結果為最差，以此作為發報告之依據。	
EUT	
1	GTM46161-165.0-USB
2	GTM46161-165.5-USB
3	GTM46161-165.0-USB1A
4	GTM46161-165.5-USB1A
5	GTM46161-165.0-USB2A
6	GTM46161-165.5-USB2A
7	GTM46161-165.0-USBC
8	GTM46161-165.5-USBC
9	GTM46161-165.0-USB1A1C
10	GTM46161-165.5-USB1A1C
11	GTM46161-165.0-USB2C
12	GTM46161-165.5-USB2C



1.3. 受測裝置之系統說明

設備	廠牌	型號	檢磁號碼	備註
Multi Meter	G.W.	GDM-357	N/A	N/A
Cement Resistance*2	Shine Time	N/A	N/A	400W 10Ω

1.4. 測試週邊配置圖

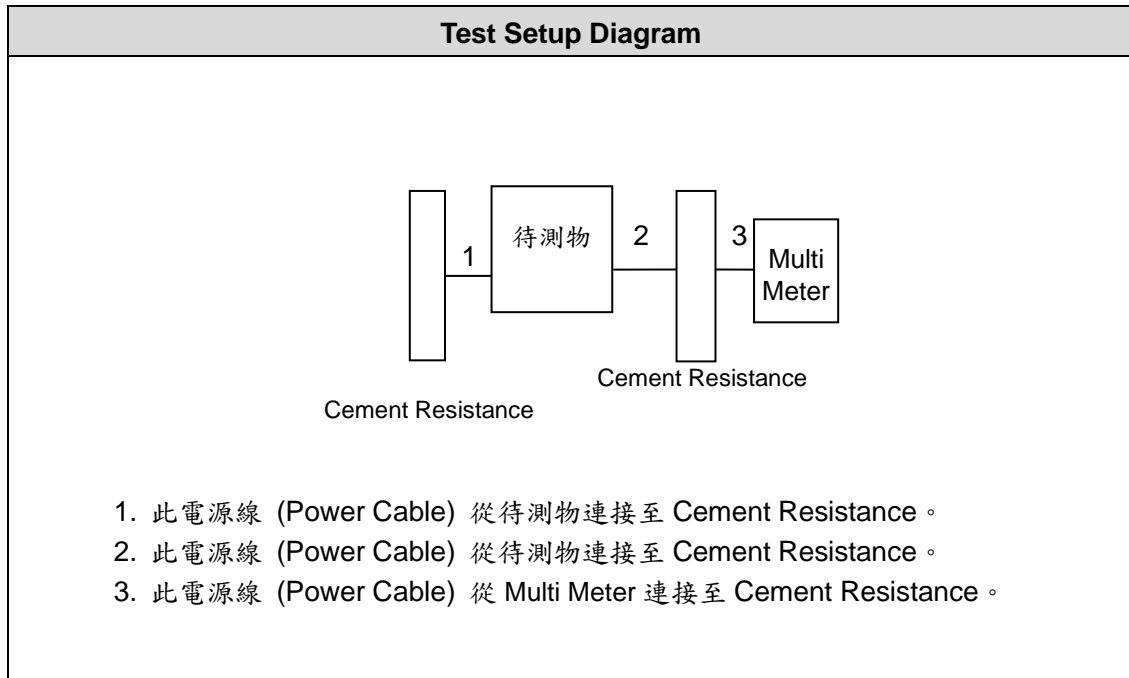



2. 測試情形之描述

2.1. 測試場地

測試場地位置	世騰電子科技股份有限公司 桃園市蘆竹區聯福街 2 巷 10 號 電話：886-3-3226-888 傳真：886-3-3226-881	
	傳導測試場地	CON01-NK, CON02-NK
	10M測試場地	10M01-NK
	3M測試場地	3M01-NK, 3M02-NK

2.2. 測試電壓

AC 110V / 60Hz

2.3. 量測方法之法規

CNS 15936 乙類

2.4. 測試依據法規

CNS 15936 乙類

2.5. 量測頻率範圍

傳導干擾量測：自 150 KHz 至 30 MHz (含異對稱模式之傳導擾動測試)。

輻射干擾量測：自 30 MHz 至 1000 MHz, 自 1000 MHz 至 6000 MHz。

差模傳導電壓放射測試：本產品無 TV/FM 廣播接收機調諧器埠，故不需量測差模傳導電壓放射測試。

FM 接收機之輻射測試：本產品無 FM 功能，故不需量測 FM 接收機之輻射測試。

2.6. 量測距離

天線至待測設備之輻射干擾場強量測距離為 10 米及 3 米(1G 以上)

2.7. 量測不確定度

Measurement Item	Measurement Frequency	Polarization	Uncertainty
Conducted Emission	150 kHz ~ 30 MHz	LINE / NEUTRAL	±3.10dB
Asymmetric Mode	150 kHz ~ 30 MHz	N/A	±3.64dB
Radiated Emission	30 MHz ~ 1,000 MHz	Vertical / Horizontal	±5.08dB
	1,000 MHz ~ 6,000 MHz	Vertical / Horizontal	±5.15dB
	6,000 MHz ~ 18,000 MHz	Vertical / Horizontal	±5.25dB

ISO/IEC 17025 requires that an estimate of the measurement uncertainties associated with the emissions test results be included in the report. The measurement uncertainties given below are based on a 95% confidence level (based on a coverage factor (k=2)).



3. 電源線與異對稱模式之傳導擾動之量測規定

3.1. 電源線與異對稱模式之傳導擾動之量測規定

3.1.1. 適用標準

電源線傳導干擾電壓之量測係依據 CNS 15936 附錄 C 與附錄 D 之量測方法，量測儀器以 9kHz 之頻寬，從 150kHz 至 30MHz 之頻段量測待測物電壓，自電源線送出之干擾訊號。所有週邊及連接線之位置及擺設在合理及可能的應用情形下變換位置以獲得最大之傳導干擾電壓。

乙類設備交流電源端之傳導擾動限制值

適用 AC 電源埠				
表格條款	頻率範圍 MHz	耦合裝置	檢波器型式 / 頻寬	乙類電壓限制值 dB(μV)
A10.1	0.15 – 0.5	AMN	Quasi Peak / 9 kHz	66 – 56
	0.5 - 5			56
	5 - 30			60
A10.2	0.15 – 0.5	AMN	Average / 9 kHz	56 – 46
	0.5 - 30			46
	5 - 30			50

整個頻率範圍適用 A10.1 和 A10.2。

3.1.2. 測試方式

- 待測物被放置於離垂直參考地面 0.4 米的位置。
- 將待測物之電源連接至 LISN 之電源輸出端，並將 LISN 之電源輸入端接至經過電源濾波器之電源；待測物之訊號線接至 ISN 之 EUT 端。
- 將週邊之電源接至輔助 LISN 之電源輸出端；週邊之訊號線接至 ISN 之 AE 端。
- ISN 提供 50ohm 耦合阻抗至量測儀器。
- 訊號線被檢查及量測以獲得最大之電信埠擾動值。
- 量測之頻率範圍自 150KHz 至 30MHz。
- 設定量測儀器至峰值偵測功能，且指定頻寬，再執行峰值保留模式開始量測。
- 選擇至少最高之 6 點，進行準峰值及平均值量測，並記錄於試驗報告中。



3.2. 異對稱模式之傳導擾動

3.2.1. 適用標準

電信埠傳導干擾之量測係依據 CNS 15936 附錄 C 與附錄 D 之量測方法之量測方法，量測儀器以 9kHz 之頻寬，從 150kHz 至 30MHz 之頻段量測待測物電信埠之干擾訊號。待測物的擺設方式如 CNS 15936 附錄 D.2 所示。

乙類設備異對稱模式之傳導擾動限制值

適用性: 1. 有線網路埠 2. 有金屬屏蔽或張力環之光纖埠 3. 廣播接收機調諧器埠 4. 天線埠					
表格條款	頻率範圍 MHz	耦合裝置	檢波器型式 / 頻寬	乙類電壓限制值 dB(μV)	乙類電流限制值 dB(μA)
A12.1	0.15 – 0.5	AAN	Quasi Peak / 9 kHz	84 – 74	N/A
	0.5 - 30			74	
	0.15 – 0.5	AAN	Average / 9 kHz	74 – 64	
	0.5 - 30			64	
A12.2	0.15 – 0.5	CVP and current probe	Quasi Peak / 9 kHz	84 – 74	40 – 30
	0.5 - 30			74	30
	0.15 – 0.5	CVP and current probe	Average / 9 kHz	74 – 64	30 – 20
	0.5 - 30			64	20
A12.3	0.15 – 0.5	Current Probe	Quasi Peak / 9 kHz	N/A	40 – 30
	0.5 - 30				30
	0.15 – 0.5	Current Probe	Average / 9 kHz		30 - 20
	0.5 - 30				20
依據附錄 C 之規定，選擇耦合裝置及量測程序。 遮蔽埠包含 TV 廣播接收機調諧器埠，要使用 150 歐姆共模阻抗測試，一般是在遮蔽層以 150 歐姆中接到地，以實現此特點。 具有線網路埠功能之 AC 電源埠，必須符合電源埠限制值。 測試需涵蓋整個頻率範圍。 依據所有的量測程序，應用電壓及/或電流限制值。 只需再一種 EUT 之供應電壓及頻率執行測試。 適用於上述所序列之各種介接埠，而且意圖連接到超過 3m 長之纜線。					

3.2.2. 測試方法

- 待測物被放置於離垂直參考地面 0.4 米的位置。
- 將待測物之電源連接至 LISN 之電源輸出端，並將 LISN 之電源輸入端接至經過電源濾波器之電源；待測物之訊號線接至 ISN 之 EUT 端。
- 將週邊之電源接至輔助 LISN 之電源輸出端；週邊之訊號線接至 ISN 之 AE 端。
- ISN 提供 50ohm 耦合阻抗至量測儀器。
- 訊號線被檢查及量測以獲得最大之電信埠擾動值。
- 量測之頻率範圍自 150KHz 至 30MHz。
- 設定量測儀器至峰值偵測功能，且指定頻寬，再執行峰值保留模式開始量測。
- 選擇至少最高之 6 點，進行準峰值及平均值量測，並記錄於試驗報告中。

3.3. 測試擺設圖

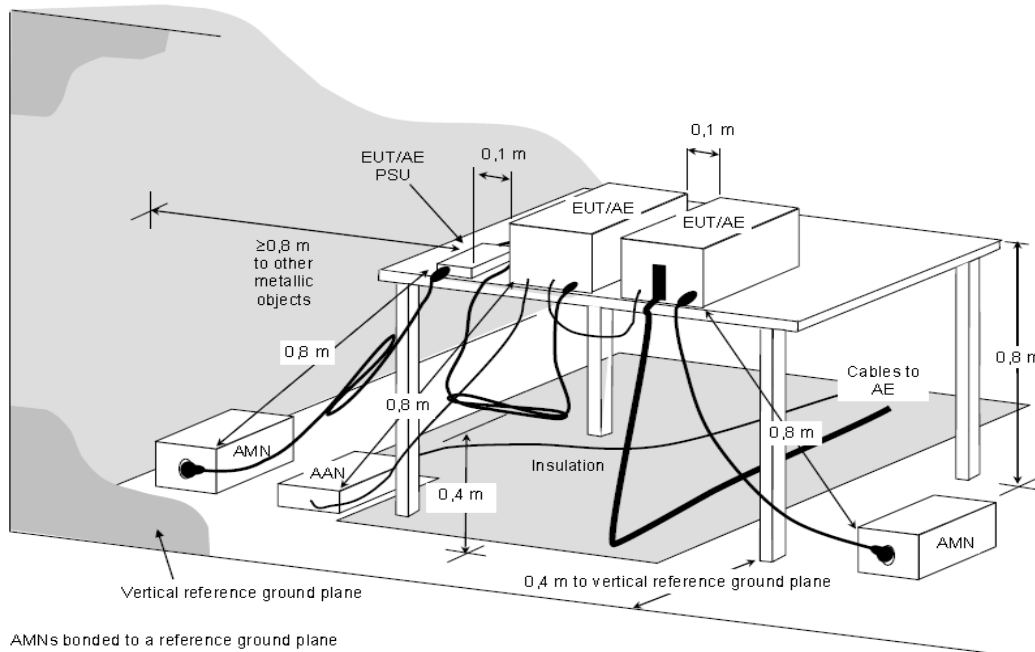

NOTE The 0,8 m distance specified between EUT/AE/PSU and AMN/AAN, is applicable only to the EUT being measured. If the device is AE then it shall be $\geq 0,8$ m.

3.4. 測試儀器

儀器名稱	廠商	型號	序號	校驗日期	下次校驗日期
EMI Receiver	R&S	ESCI	101200	2023/08/25	2024/08/24
LISN	Schwarzbeck	NSLK 8127	8127-740	2023/08/28	2024/08/27
Power Box	N/A	PX-01	PB-01	2023/10/04	2024/10/03
Pulse Limiter	R&S	ESH3-Z2	101934	2023/02/24	2024/02/23
Cable-4m (9kHz~300MHz)	EMEC	RG-223	18495M	2023/08/31	2024/07/29
Software	AUDIX	E3	Version: V8.2014-8-6	N/A	N/A



3.5. 電源端之傳導干擾測試結果及數據

Test Mode	Mode 24	Pol/Phase	LINE
Test Frequency	0.15 MHz ~ 30 MHz	Test Voltage	AC 110V/60Hz
Test Date	Jan. 25, 2024	Test Engineer	Wei
Temperature	20°C	Relative Humidity	50%

Note : Level = Reading + Factor
 Margin = Level – Limit
 Factor= (LISN or PLC or Current Probe) Factor + Cable Loss + Attenuator

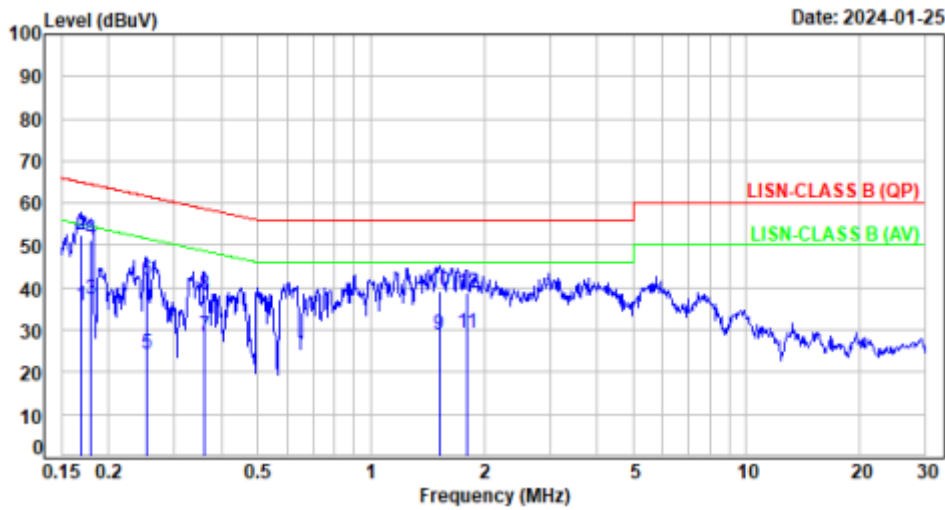

No.	Frequency (MHz)	Factor (dB)	Reading (dBuV)	Level (dBuV)	Limit (dBuV)	Margin (dB)	Detector	P/F
1	0.17	9.95	25.98	35.93	55.03	-19.10	Average	P
2	0.17	9.95	42.33	52.28	65.03	-12.75	QP	P
3	0.18	9.96	27.36	37.32	54.50	-17.18	Average	P
4	0.18	9.96	41.53	51.49	64.50	-13.01	QP	P
5	0.25	9.97	14.21	24.18	51.69	-27.51	Average	P
6	0.25	9.97	31.67	41.64	61.69	-20.05	QP	P
7	0.36	9.98	18.53	28.51	48.74	-20.23	Average	P
8	0.36	9.98	28.59	38.57	58.74	-20.17	QP	P
9	1.52	10.09	18.75	28.84	46.00	-17.16	Average	P
10	1.52	10.09	29.20	39.29	56.00	-16.71	QP	P
11	1.80	10.10	19.02	29.12	46.00	-16.88	Average	P
12	1.80	10.10	28.69	38.79	56.00	-17.21	QP	P



Test Mode	Mode 24	Pol/Phase	NEUTRAL
Test Frequency	0.15 MHz ~ 30 MHz	Test Voltage	AC 110V/60Hz
Test Date	Jan. 25, 2024	Test Engineer	Wei
Temperature	20°C	Relative Humidity	50%

Note : Level = Reading + Factor
 Margin = Level – Limit
 Factor= (LISN or PLC or Current Probe) Factor + Cable Loss + Attenuator

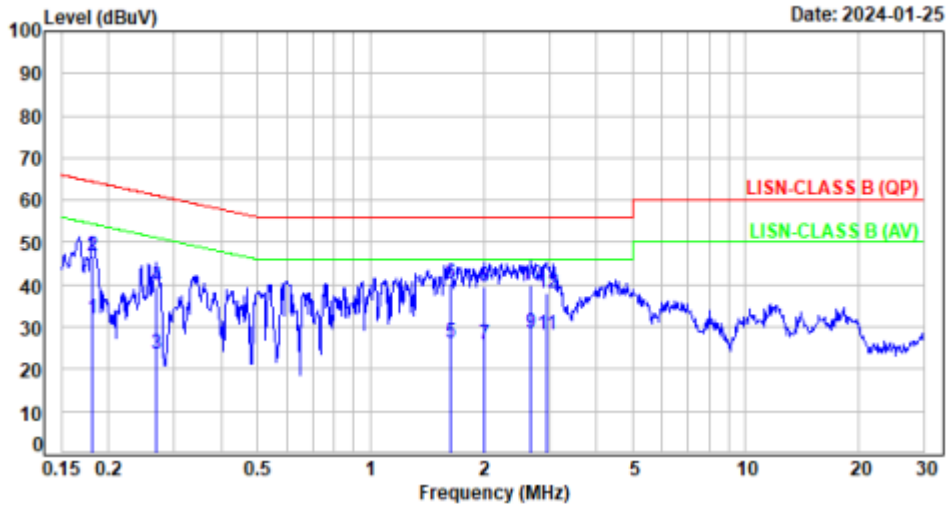

No.	Frequency (MHz)	Factor (dB)	Reading (dBuV)	Level (dBuV)	Limit (dBuV)	Margin (dB)	Detector	P/F
1	0.18	9.99	22.08	32.07	54.46	-22.39	Average	P
2	0.18	9.99	36.68	46.67	64.46	-17.79	QP	P
3	0.27	10.00	13.76	23.76	51.16	-27.40	Average	P
4	0.27	10.00	29.70	39.70	61.16	-21.46	QP	P
5	1.64	10.12	16.28	26.40	46.00	-19.60	Average	P
6	1.64	10.12	30.07	40.19	56.00	-15.81	QP	P
7	2.00	10.14	15.73	25.87	46.00	-20.13	Average	P
8	2.00	10.14	29.50	39.64	56.00	-16.36	QP	P
9	2.68	10.20	18.14	28.34	46.00	-17.66	Average	P
10	2.68	10.20	29.58	39.78	56.00	-16.22	QP	P
11	2.95	10.21	17.74	27.95	46.00	-18.05	Average	P
12	2.95	10.21	27.93	38.14	56.00	-17.86	QP	P



Test Mode	Mode 25	Pol/Phase	LINE
Test Frequency	0.15 MHz ~ 30 MHz	Test Voltage	AC 110V/60Hz
Test Date	Jan. 25, 2024	Test Engineer	Wei
Temperature	20°C	Relative Humidity	50%

Note : Level = Reading + Factor
 Margin = Level – Limit
 Factor= (LISN or PLC or Current Probe) Factor + Cable Loss + Attenuator

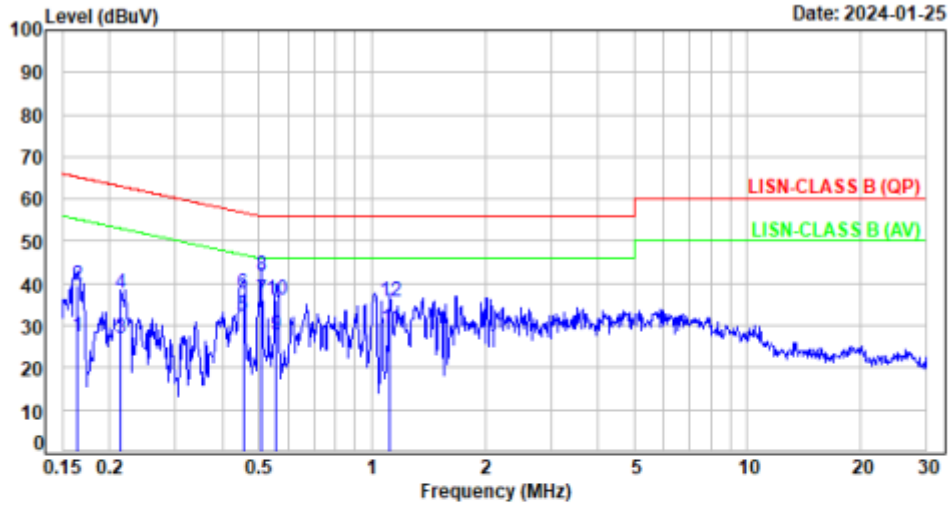

No.	Frequency (MHz)	Factor (dB)	Reading (dBuV)	Level (dBuV)	Limit (dBuV)	Margin (dB)	Detector	P/F
1	0.16	9.95	17.51	27.46	55.25	-27.79	Average	P
2	0.16	9.95	29.59	39.54	65.25	-25.71	QP	P
3	0.22	9.96	17.09	27.05	53.01	-25.96	Average	P
4	0.22	9.96	27.52	37.48	63.01	-25.53	QP	P
5	0.45	9.99	22.30	32.29	46.80	-14.51	Average	P
6	0.45	9.99	27.77	37.76	56.80	-19.04	QP	P
7	0.51	9.99	26.05	36.04	46.00	-9.96	Average	P
8	0.51	9.99	31.77	41.76	56.00	-14.24	QP	P
9	0.56	9.99	17.58	27.57	46.00	-18.43	Average	P
10	0.56	9.99	26.20	36.19	56.00	-19.81	QP	P
11	1.12	10.05	19.07	29.12	46.00	-16.88	Average	P
12	1.12	10.05	25.75	35.80	56.00	-20.20	QP	P



Test Mode	Mode 25	Pol/Phase	NEUTRAL
Test Frequency	0.15 MHz ~ 30 MHz	Test Voltage	AC 110V/60Hz
Test Date	Jan. 25, 2024	Test Engineer	Wei
Temperature	20°C	Relative Humidity	50%

Note : Level = Reading + Factor
 Margin = Level – Limit
 Factor= (LISN or PLC or Current Probe) Factor + Cable Loss + Attenuator

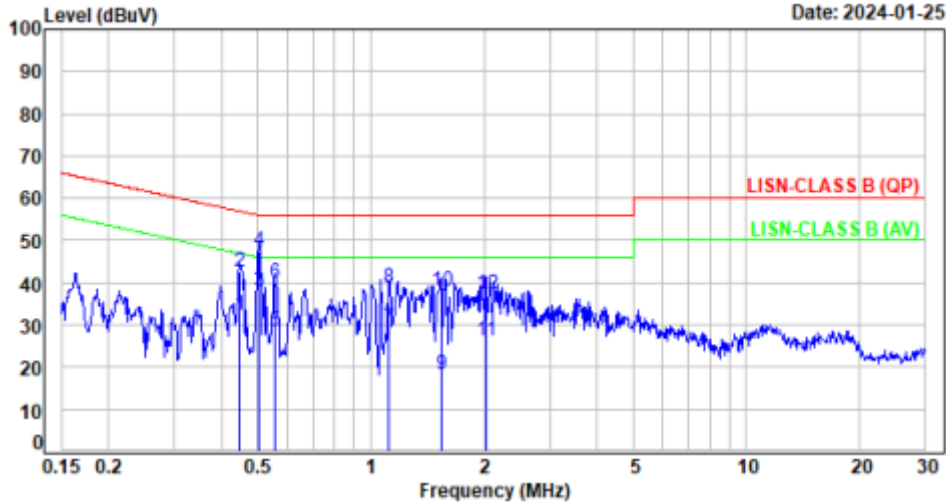

No.	Frequency (MHz)	Factor (dB)	Reading (dBuV)	Level (dBuV)	Limit (dBuV)	Margin (dB)	Detector	P/F
1	0.45	10.01	22.23	32.24	46.89	-14.65	Average	P
2	0.45	10.01	32.75	42.76	56.89	-14.13	QP	P
3	0.50	10.02	27.95	37.97	46.00	-8.03	Average	P
4	0.50	10.02	37.63	47.65	56.00	-8.35	QP	P
5	0.56	10.02	18.63	28.65	46.00	-17.35	Average	P
6	0.56	10.02	29.75	39.77	56.00	-16.23	QP	P
7	1.12	10.07	19.20	29.27	46.00	-16.73	Average	P
8	1.12	10.07	28.71	38.78	56.00	-17.22	QP	P
9	1.54	10.11	8.25	18.36	46.00	-27.64	Average	P
10	1.54	10.11	28.04	38.15	56.00	-17.85	QP	P
11	2.02	10.14	16.05	26.19	46.00	-19.81	Average	P
12	2.02	10.14	27.07	37.21	56.00	-18.79	QP	P



3.6. 異對稱模式測試結果及數據

因本申請件無電信埠，故不需量測異對稱模式之傳導擾動。

3.7. 電源端之傳導干擾配置照片

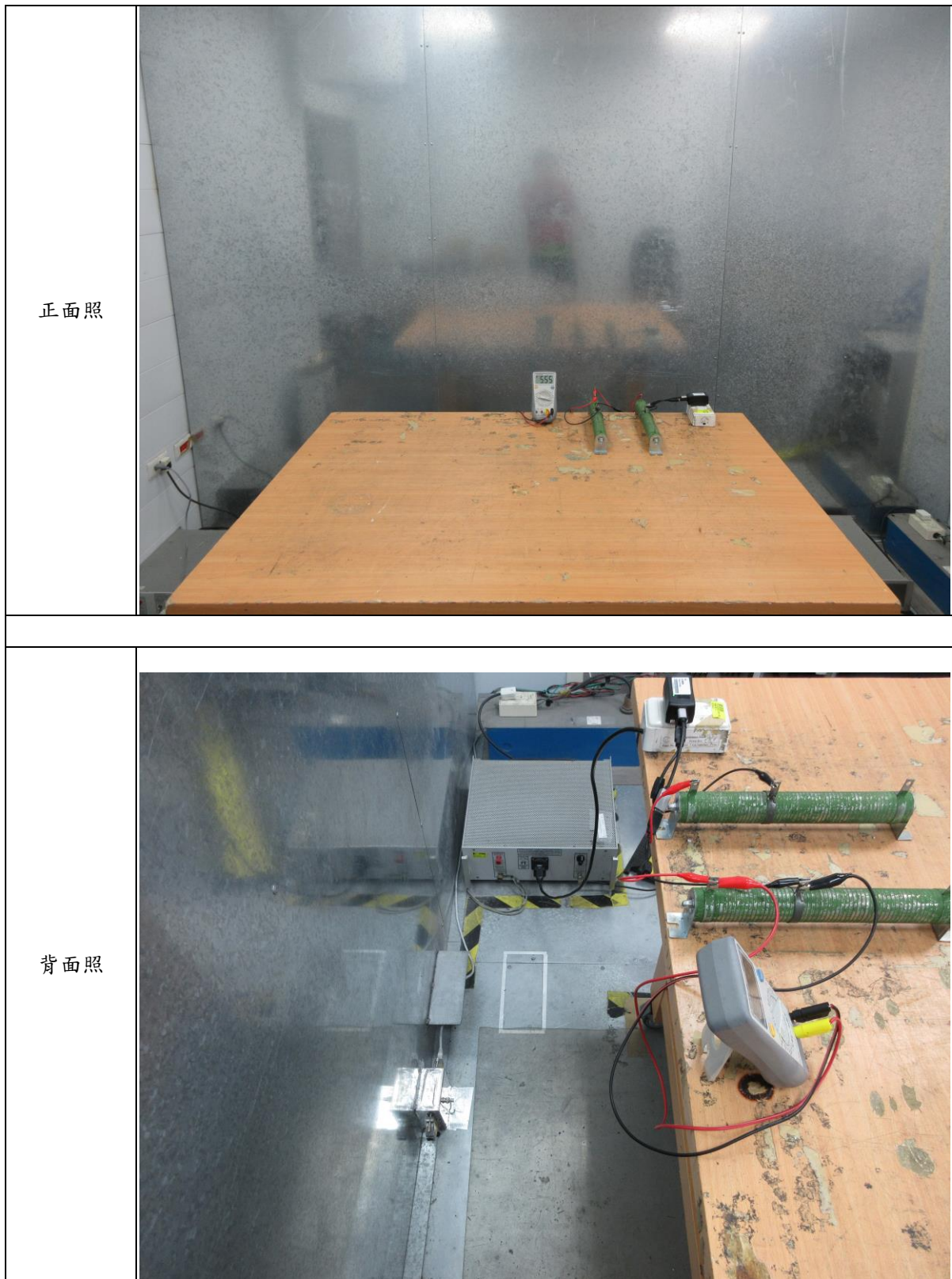



4. 差模傳導電壓放射量測

4.1. 適用標準

差模傳導電壓放射量測係依照 CNS 15936 附錄 C 第 C.4.2.2 節之測試方法量測,量測範圍自 30MHz 至 2150MHz。待測物與量測儀器配置圖請參考章節 6.3。

乙類設備差模傳導電壓放射要求之限制值 (天線端輸入阻抗為75Ω)

表格 條款	頻率範圍 MHz	檢波器型式 / 頻寬	乙類限制值 dB(μV)75Ω			適用性	
			其他	本地震盪器 基本波	本地震盪器 諧波		
A13.1	30 - 950	頻率≤1 GHz	46	46	46	參照(a)	
	950 - 2150		46	54	54		
A13.2	950 - 2150	Quasi Peak / 120 kHz	46	54	54	參照(b)	
A13.3	30 - 300		頻率 ≥ 1 GHz	46	54	50	參照(c)
	300 - 1000					52	
A13.4	30 - 300		Peak / 1 MHz	46	66	59	參照(d)
	300 - 1000	52					
A13.5	30 - 950	Peak / 1 MHz	46	76	46	參照(e)	
	950 - 2150			N/A	54		

(a) 電視接收機(類比或數位)、錄影機及 PC 之 TV 廣播接收機調諧器卡,工作於 30MHz 和 1GHz 之間的頻道,以及數位聲音接收機。
 (b) 衛星信號接收用之調諧器單元(非低雜訊集波器(LNB))。
 (c) 調諧器聲音接收機及 PC 之調諧器卡。
 (d) 調頻汽車收音機。
 (e) 適用於具有射頻調變器輸出埠之 EUT(例:DVD 裝置、錄影機、攝錄影機及解碼機等),其輸出埠係設計來連 TV 廣播接收機之調諧器埠的。LO 限制值細微 RF 調變器載波信號和其諧波兒規定的。
 表中的"其他"表示除了本地振盪器之基頻及其諧波以外的所有發射。

4.2. 測試程序

於 EUT 之 TV/FM 廣播接收機調諧器埠執行量測時,應由 1 台信號產生器產生未調變的載波,用以饋入接收機之輸入端,饋入之設頻訊號要為 EUT 所調諧之頻率。

信號產生器之輸出位準,針對 FM 接收機應設定產生 60 dBuV,針對 TV 接收機則為 70 dBuV,前述情況之位準,係跨在接收機輸入端阻抗之電壓(通常為 75Ω),並依據 CNS 15936 附錄 C 4.2 量測方法測試。

4.3. 測試擺設圖

在 TV/FM 廣播接收機調諧器埠量測放射電壓之配置

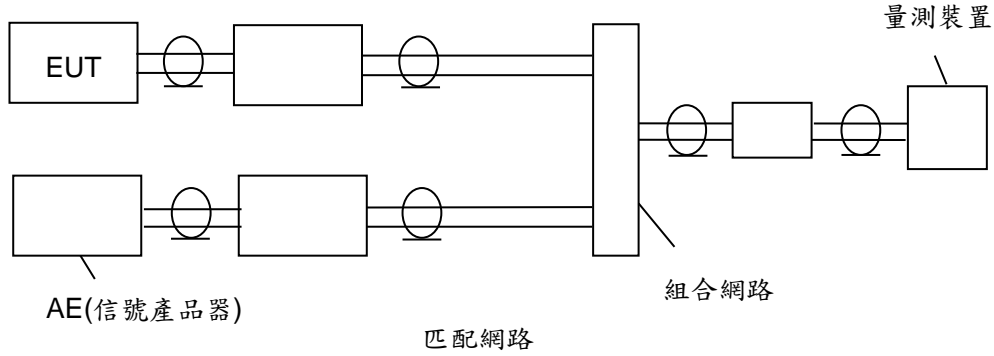

在 EUT 之 RF 調變器輸出埠量測所需訊號及放射電壓之配置

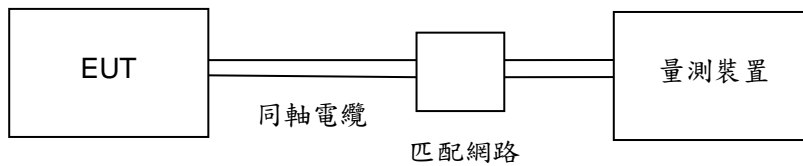

4.4. 測試結果及數據

本產品無 TV/FM 廣播接收機調諧器埠，故不需量測差模傳導電壓放射測試。



5. 輻射干擾場強之量測

5.1. 適用標準

輻射干擾場強量測係依照 CNS 15936 附錄 C 與附錄 D 之量測方法量測，測試取樣頻寬為 120kHz 量測範圍自 30MHz 至 1000MHz 及頻寬為 1MHz 量測範圍自 1000MHz 至 6000MHz。(場地配置圖請參考附錄 D 3.2.)。所有支援週邊及連接線位置均以合理且可能之應用情況，做任意擺設以獲得最大之輻射干擾場強。

乙類設備在頻率至 1GHz 為止之輻射放射要求

表格條款	頻率範圍 MHz	量測			乙類限制值 dB(uV/m)
		設施	距離 m	檢波器型式 /頻寬	
A4.1	30 – 230	OATS/SAC	10	Quasi Peak / 120kHz	30
	230 – 1000				37

此等要求並不適用於本地振盪器以及表 A.6 設備之諧波率。

乙類設備在頻率超過 1GHz 之輻射放射要求

表格條款	頻率範圍 MHz	量測			乙類限制值 dB(uV/m)
		設施	距離 m	檢波器型式 /頻寬	
A5.1	1 000 – 3 000	FSOATS	3	Average / 1 MHz	50
	3 000 – 6 000				54
A5.2	1 000 – 3 000			Peak / 1 MHz	70
	3 000 – 6 000				74

從 1GHz 開始至表 1 所推導之最高要求量測頻率，要適用 A5.1 和 A5.2。

表 1 輻射量測所要求之最高頻率

最高內頻 (Fx)	最高量測頻率
Fx ≤ 108MHz	1GHz
108MHz < Fx ≤ 500MHz	2GHz
500MHz < Fx ≤ 1GHz	5GHz
Fx > 1GHz	5x Fx 一直到最大 6GHz 為止

備考 1. 針對調頻(FM)及電視(TV)廣播接收機而言，Fx 係由所產生或所使用之最高頻率決定，但排除本地振盪器及調諧之頻率。

備考 2. Fx 定義在 3.1.18。

備考 3. 家用衛星接收系統之室外單元，最高量測頻率應為 18GHz。

備考 4. 當 Fx 為未知時，輻射放射量測應執行至 6GHz。

5.2. 測試程序

- 待測物放置於離金屬地平面 0.8 m，且可旋轉之木桌上。
- 置天線於離待測物 10 m 或 3m 之處，且將天線安裝於可升降改變高度及旋轉改變水平，垂直之天線架上。
- 將所有支援週邊及待測設備樣品之電源開啟，並執行適當的測試程式。
- 設定測試儀器至峰值偵測功能並且設定頻寬及峰值保留模式。
- 待測物放置於木桌上自 0 度旋轉至 360 度以獲得最大輻射干擾場強之角度位置。
- 天線以水平極性及垂直極性由離地 1 m 至 4 m 高度移動位置以獲得最大之輻射強度。
- 若待測物之輻射峰值低於限制值 6dB 以上，則將終止測試，並以峰值之讀值作為報告之紀錄；反之，若無 6dB 餘裕範圍之輻射訊號，則每一訊號皆以準峰值或平均值之測試方法量測，並記錄於報告之中。

5.3. 測試擺設圖

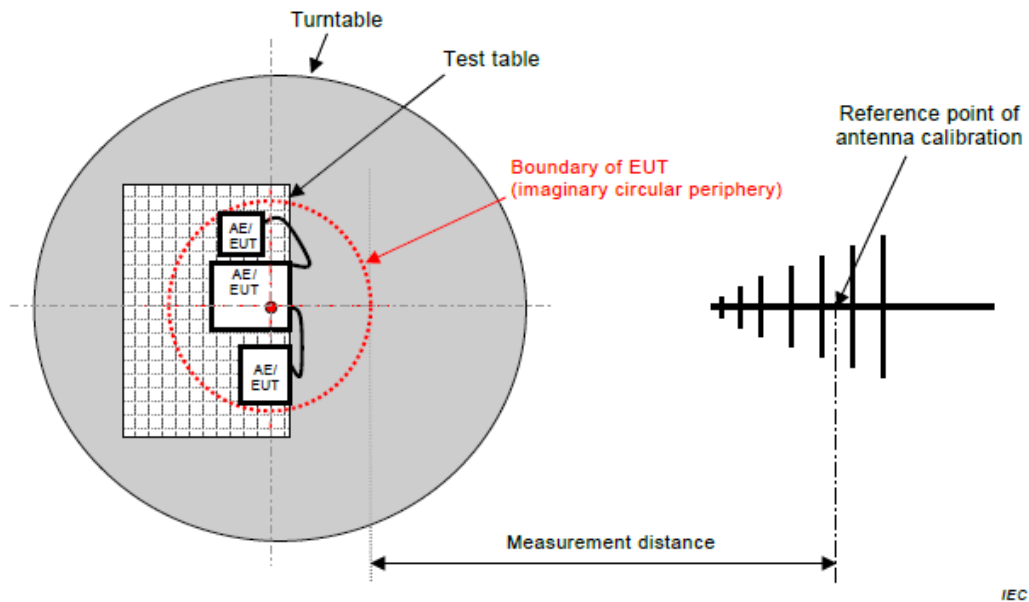
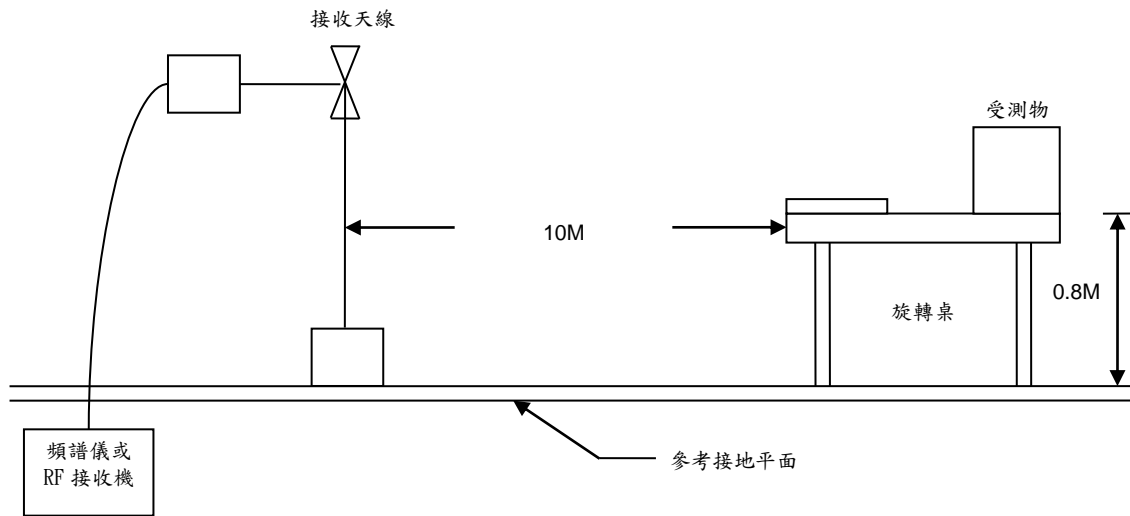

Figure C.1 – Measurement distance



1GHz 以下測試擺設圖



1GHz 以上測試擺設圖

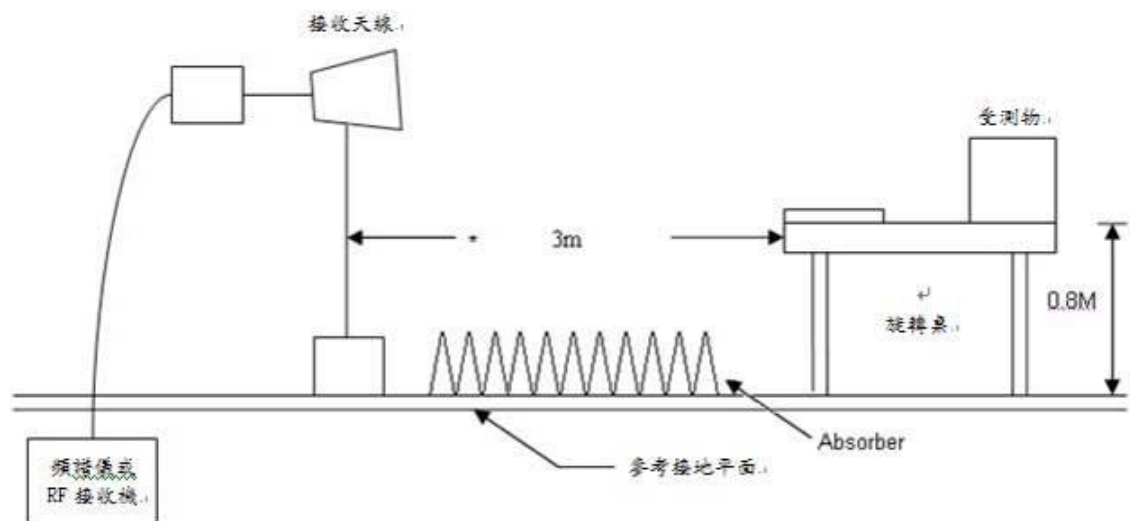



5.4. 測試儀器

儀器名稱	廠商	型號	設備序號	校驗日期	下次校驗日期
Bilog Antenna(V)	Sunol	JB1	A050422	2023/09/18	2024/09/17
Bilog Antenna(H)	Sunol	JB1	A020514-1	2023/05/09	2024/05/08
EMI Receiver(V)	R&S	ESCI	100443	2023/06/26	2024/06/25
EMI Receiver(H)	R&S	ESCI	101402	2023/03/02	2024/03/01
Preamplifier(V)	EM Electronics corp.	EM330	60610	2023/02/16	2024/02/15
Preamplifier(H)	EM Electronics corp.	EM330	60644	2023/09/26	2024/09/25
Cable-1m (30MHz-1GHz)(V)	HUBER SUHNER	RG-214	01126M	2023/09/01	2024/08/31
Cable-4m (30MHz-1GHz)(V)	HUBER SUHNER	RG-214	05086M	2023/09/01	2024/08/31
Cable-9m (30MHz-1GHz)(V)	HUBER SUHNER	RG-214	01099M	2023/09/01	2024/08/31
Cable-16m (30MHz-1GHz)(H)	HUBER SUHNER	RG-214	01110M	2023/02/16	2024/02/15
Cable-4m ((30MHz-1GHz)(H)	HUBER SUHNER	RG-214	02951M	2023/02/16	2024/02/15
Cable-1m (30MHz-1GHz)(H)	HUBER SUHNER	RG-214	01098M	2023/02/16	2024/02/15
Software	AUDIX	E3	Version: V8.2014-8-6	N/A	N/A



5.5. 測試結果及數據 (30MHz ~ 1GHz)

Test Mode	Mode 24	PoI/Phase	VERTICAL
Test Frequency	30MHz ~ 1GHz	Test Voltage	AC 110V/60Hz
Test Date	Jan. 24, 2024	Test Engineer	Wei
Temperature	20°C	Relative Humidity	52%

Note : Level = Reading + Factor
 Margin = Level – Limit
 Factor = Antenna Factor + Cable Loss – Amplifier Factor

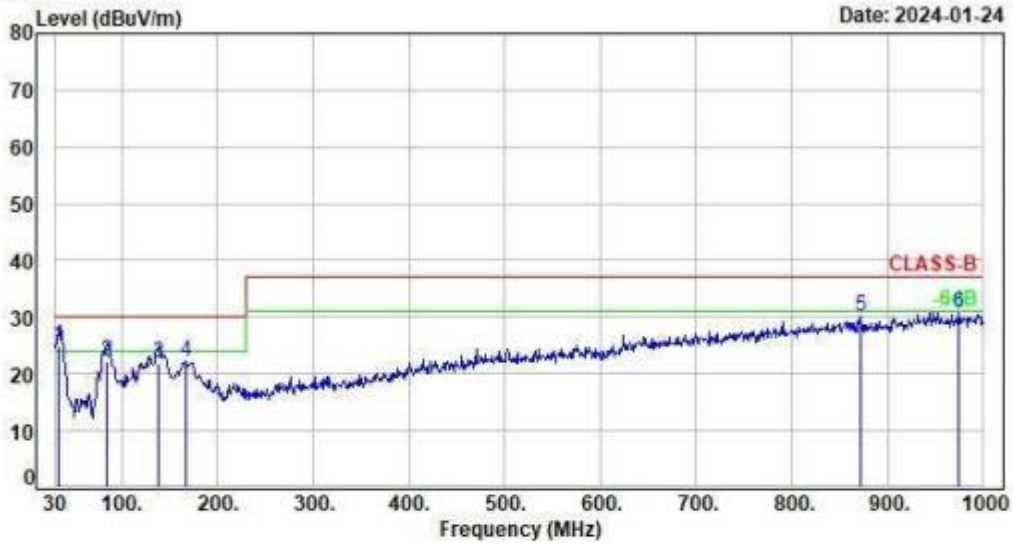

No.	Frequency (MHz)	Factor (dB/m)	Reading (dBuV)	Level (dBuV/m)	Limit (dBuV/m)	Margin (dB)	Detector	Height (cm)	Azimuth (deg)	P/F
1	33.88	-5.54	30.42	24.88	30.00	-5.12	QP	100	183	P
2	84.32	-16.21	38.51	22.30	30.00	-7.70	QP	300	9	P
3	137.67	-9.80	31.65	21.85	30.00	-8.15	QP	100	311	P
4	166.77	-10.91	33.25	22.34	30.00	-7.66	Peak	100	342	P
5	871.96	3.74	26.42	30.16	37.00	-6.84	Peak	200	162	P
6	973.81	5.15	25.72	30.87	37.00	-6.13	Peak	400	322	P



Test Mode	Mode 24	Pol/Phase	HORIZONTAL
Test Frequency	30MHz ~ 1GHz	Test Voltage	AC 110V/60Hz
Test Date	Jan. 24, 2024	Test Engineer	Wei
Temperature	20°C	Relative Humidity	52%

Note : Level = Reading + Factor
 Margin = Level – Limit
 Factor = Antenna Factor + Cable Loss – Amplifier Factor

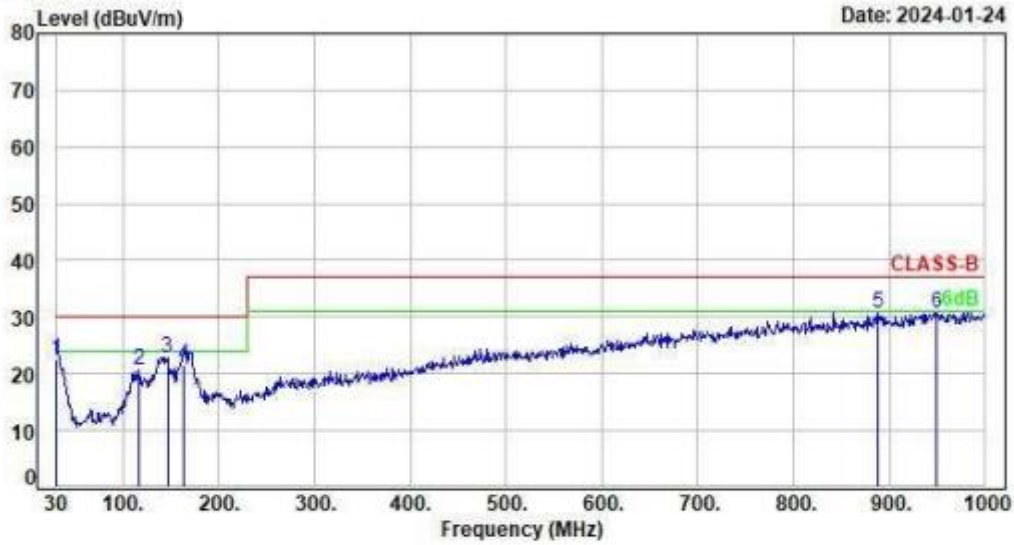

No.	Frequency (MHz)	Factor (dB/m)	Reading (dBuV)	Level (dBuV/m)	Limit (dBuV/m)	Margin (dB)	Detector	Height (cm)	Azimuth (deg)	P/F
1	30.00	-2.80	25.30	22.50	30.00	-7.50	QP	100	98	P
2	116.33	-9.95	30.55	20.60	30.00	-9.40	Peak	400	171	P
3	146.40	-10.13	33.04	22.91	30.00	-7.09	Peak	300	197	P
4	163.86	-11.13	32.61	21.48	30.00	-8.52	QP	400	202	P
5	887.48	3.26	27.35	30.61	37.00	-6.39	Peak	400	331	P
6	949.56	4.55	26.17	30.72	37.00	-6.28	Peak	100	280	P



Test Mode	Mode 25	PoI/Phase	VERTICAL
Test Frequency	30MHz ~ 1GHz	Test Voltage	AC 110V/60Hz
Test Date	Jan. 24, 2024	Test Engineer	Wei
Temperature	20°C	Relative Humidity	52%

Note : Level = Reading + Factor
 Margin = Level – Limit
 Factor = Antenna Factor + Cable Loss – Amplifier Factor

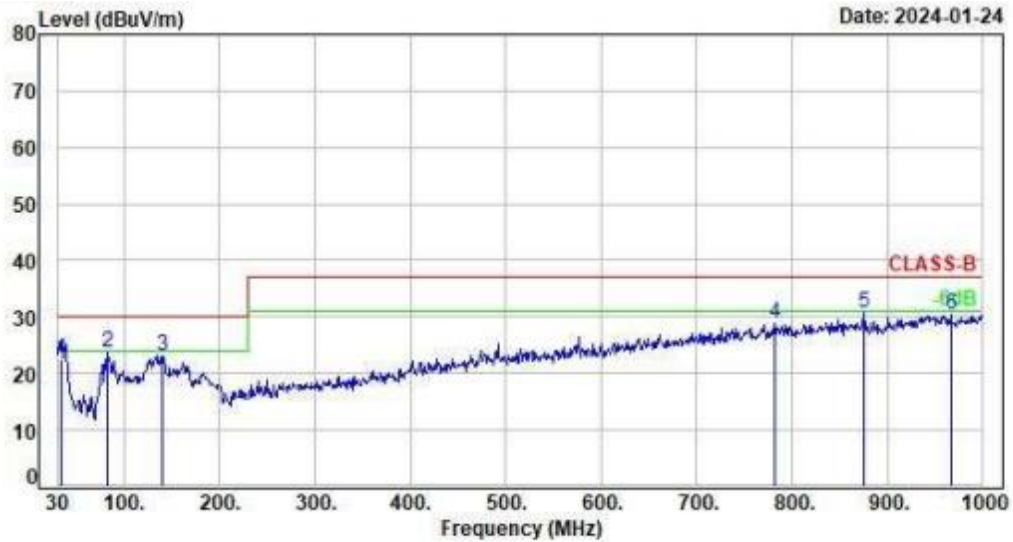

No.	Frequency (MHz)	Factor (dB/m)	Reading (dBuV)	Level (dBuV/m)	Limit (dBuV/m)	Margin (dB)	Detector	Height (cm)	Azimuth (deg)	P/F
1	33.88	-5.54	28.18	22.64	30.00	-7.36	QP	100	306	P
2	82.38	-16.10	39.68	23.58	30.00	-6.42	Peak	400	23	P
3	140.58	-10.08	33.25	23.17	30.00	-6.83	Peak	400	296	P
4	782.72	2.33	26.66	28.99	37.00	-8.01	Peak	300	72	P
5	874.87	3.78	26.82	30.60	37.00	-6.40	Peak	200	107	P
6	967.02	5.12	25.36	30.48	37.00	-6.52	Peak	200	8	P



Test Mode	Mode 25	Pol/Phase	HORIZONTAL
Test Frequency	30MHz ~ 1GHz	Test Voltage	AC 110V/60Hz
Test Date	Jan. 24, 2024	Test Engineer	Wei
Temperature	20°C	Relative Humidity	52%

Note : Level = Reading + Factor
 Margin = Level – Limit
 Factor = Antenna Factor + Cable Loss – Amplifier Factor

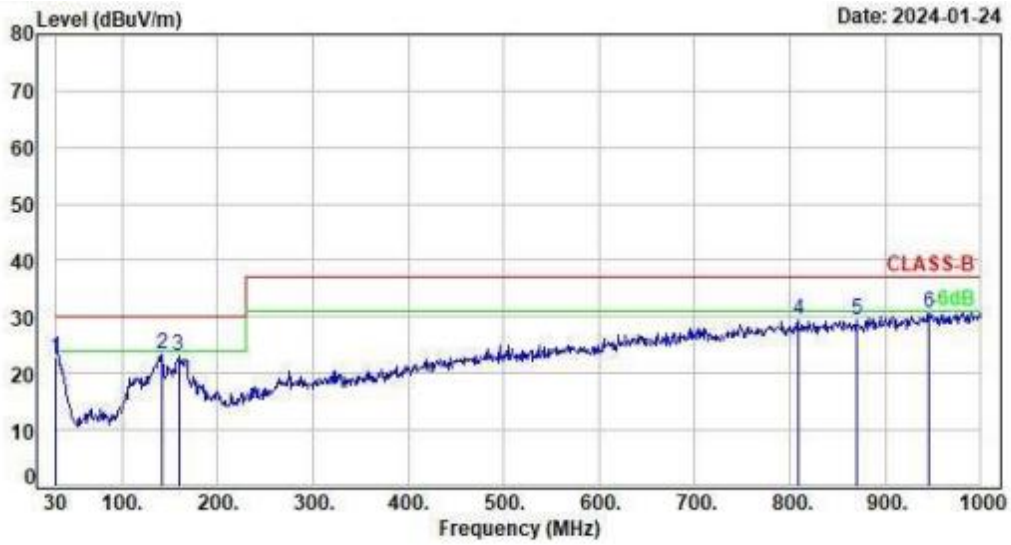

No.	Frequency (MHz)	Factor (dB/m)	Reading (dBuV)	Level (dBuV/m)	Limit (dBuV/m)	Margin (dB)	Detector	Height (cm)	Azimuth (deg)	P/F
1	30.00	-2.80	25.64	22.84	30.00	-7.16	QP	300	186	P
2	141.55	-9.81	33.23	23.42	30.00	-6.58	Peak	400	53	P
3	159.01	-11.07	34.15	23.08	30.00	-6.92	Peak	300	12	P
4	808.91	2.24	27.22	29.46	37.00	-7.54	Peak	100	72	P
5	870.02	3.03	26.53	29.56	37.00	-7.44	Peak	100	42	P
6	945.68	4.53	26.09	30.62	37.00	-6.38	Peak	200	311	P

5.6. 輻射量測之配置照片 (30MHz ~ 1GHz)

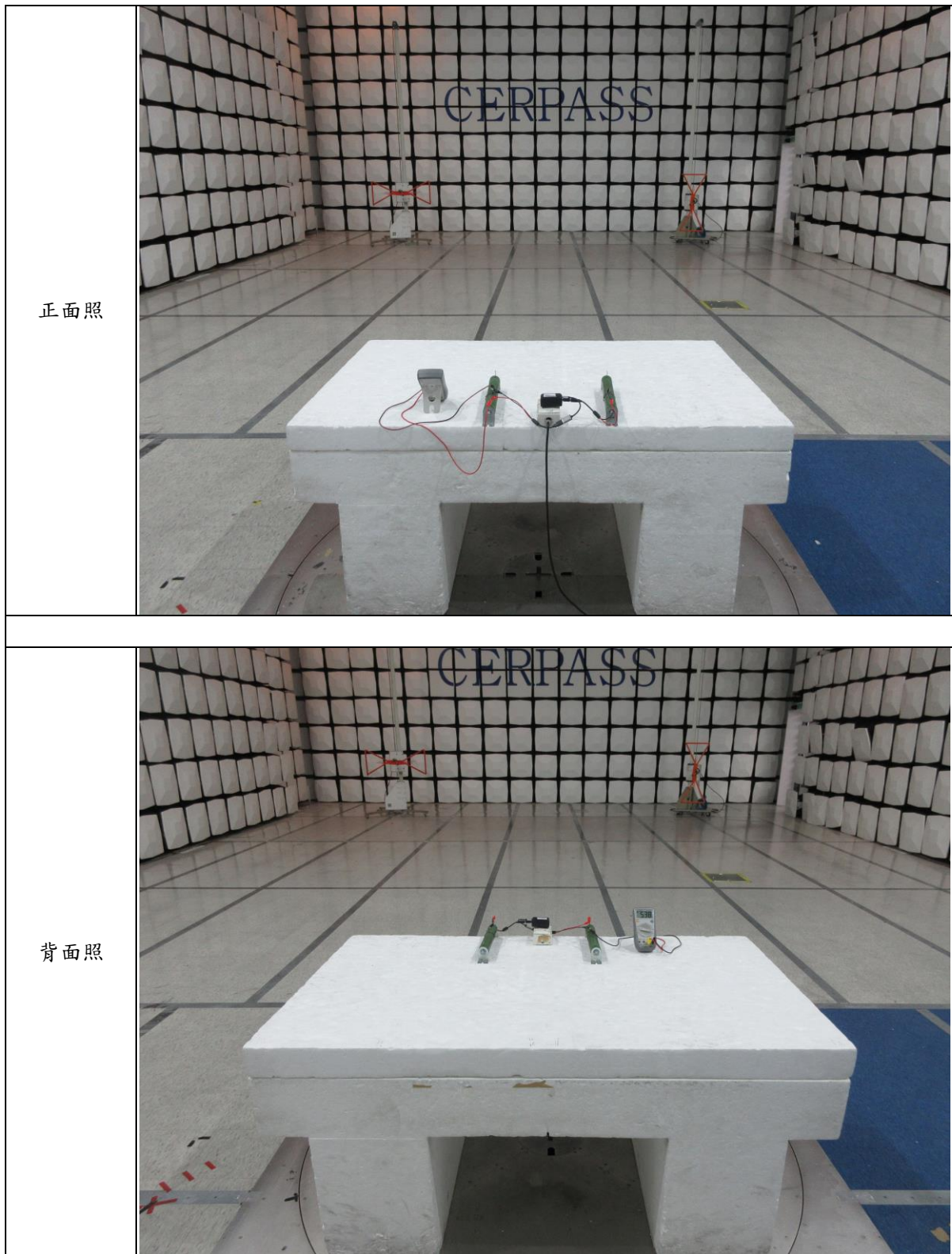



6. FM 接收機之輻射放射之量測

6.1. 適用標準

FM 接收機之輻射放射量測係依照 CNS 15936 附錄 C 第 C.1 節之測試方法量測，測試取樣頻寬為 120kHz，量測範圍自 30MHz 至 1000MHz。待測物被置於一非金屬性木桌，桌面離金屬地平面 0.8 米 (場地配置圖請參考章節 5.3.)。所有支援周邊及連接線位置均以合理且可能之應用情況，做任意擺設以獲得最大之輻射干擾場強。

FM 接收機之輻射放射要求

表格 條款	頻率範圍 MHz	量測		乙類限制值 dB(μV/m)		
		距離 m	檢波器型式 / 頻寬	基本波	諧波	
				OATS/SAC	OATS/SAC	
A6.1	30 – 230	10	Quasi peak / 120 kHz	50	42	
	230 – 300				42	
	300 – 1 000				46	
A6.2	30 – 230	3		Quasi peak / 120 kHz	60	52
	230 – 300					52
	300 – 1 000					56

NOTE 1 整個頻率範圍只適用 A.6.1 or A.6.2。

NOTE 2 放寬的限制值只適用本地震盪器(LO)的基頻與其諧波，其他頻率的訊號都必須符合表 A.4 的限制值。

6.2. 測試結果及數據

本產品無 FM 功能，故不需量測 FM 接收機之輻射測試。



7. 抑制元件及干擾源一覽表

7.1. 抑制元件

詳如申請文件之附件。

7.2. 干擾源

詳如申請文件之附件。



附錄 A. 產品照

GTM46161-165.0-USB

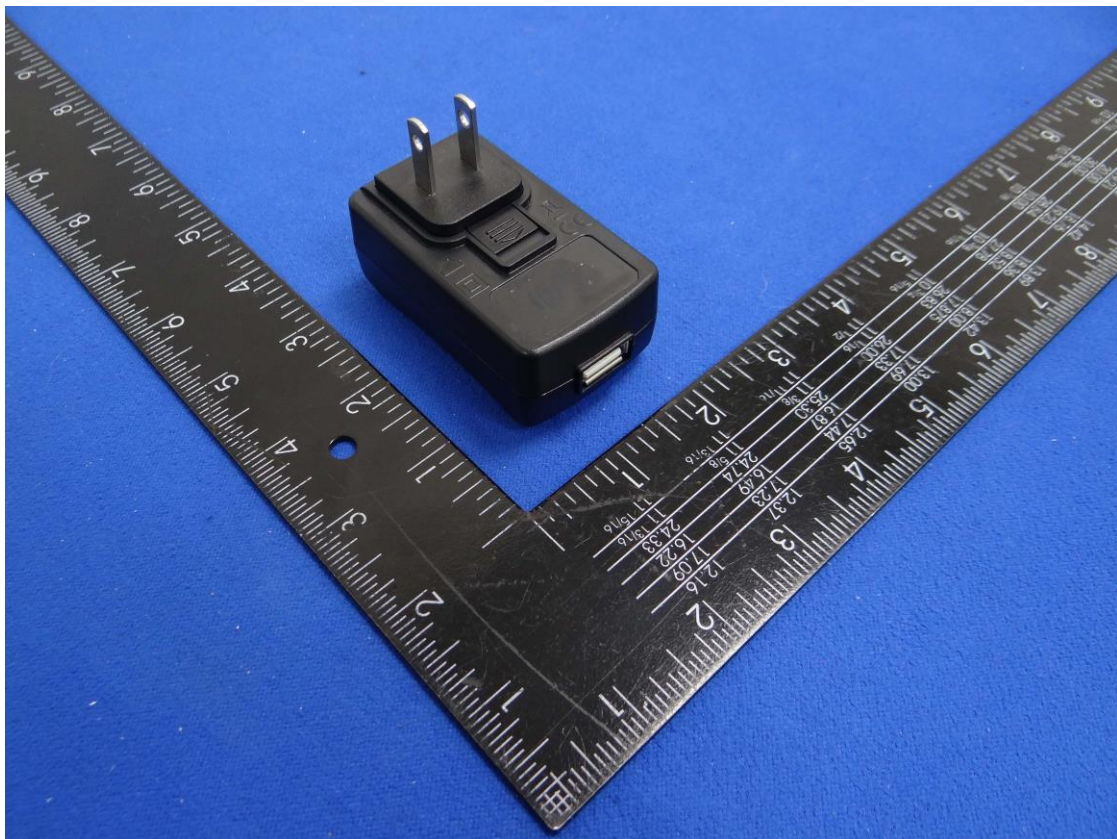
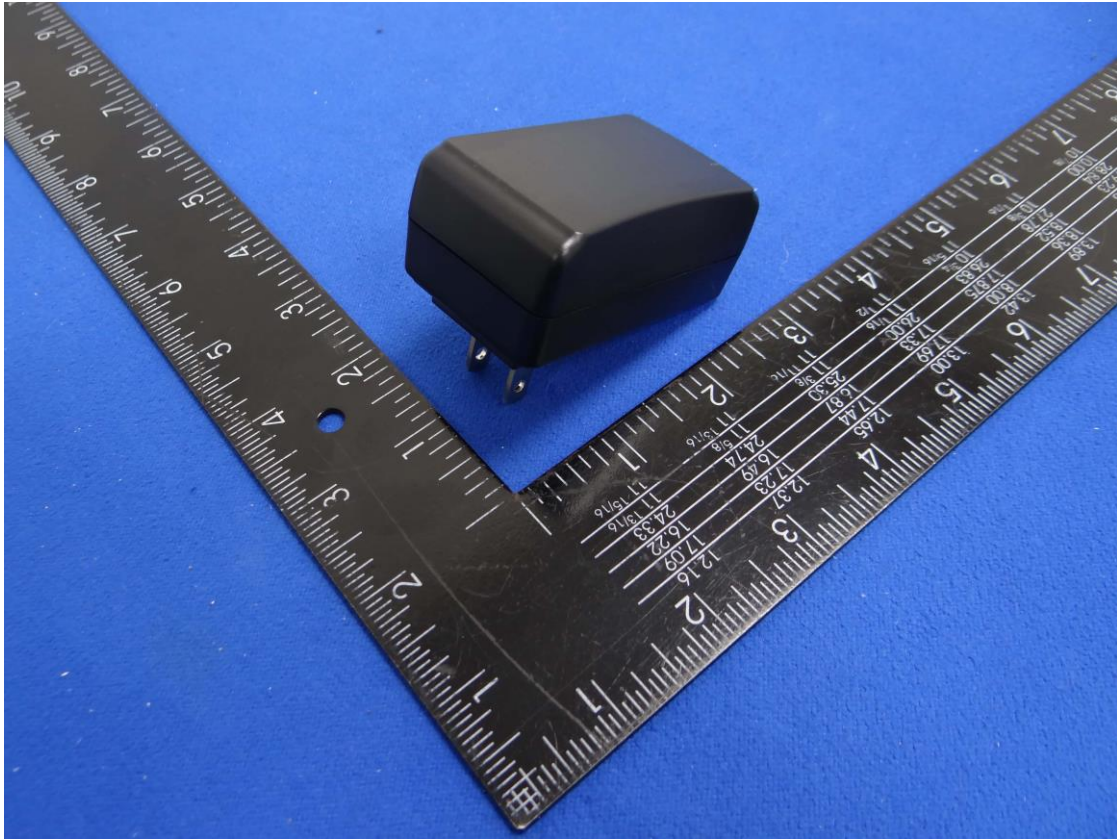



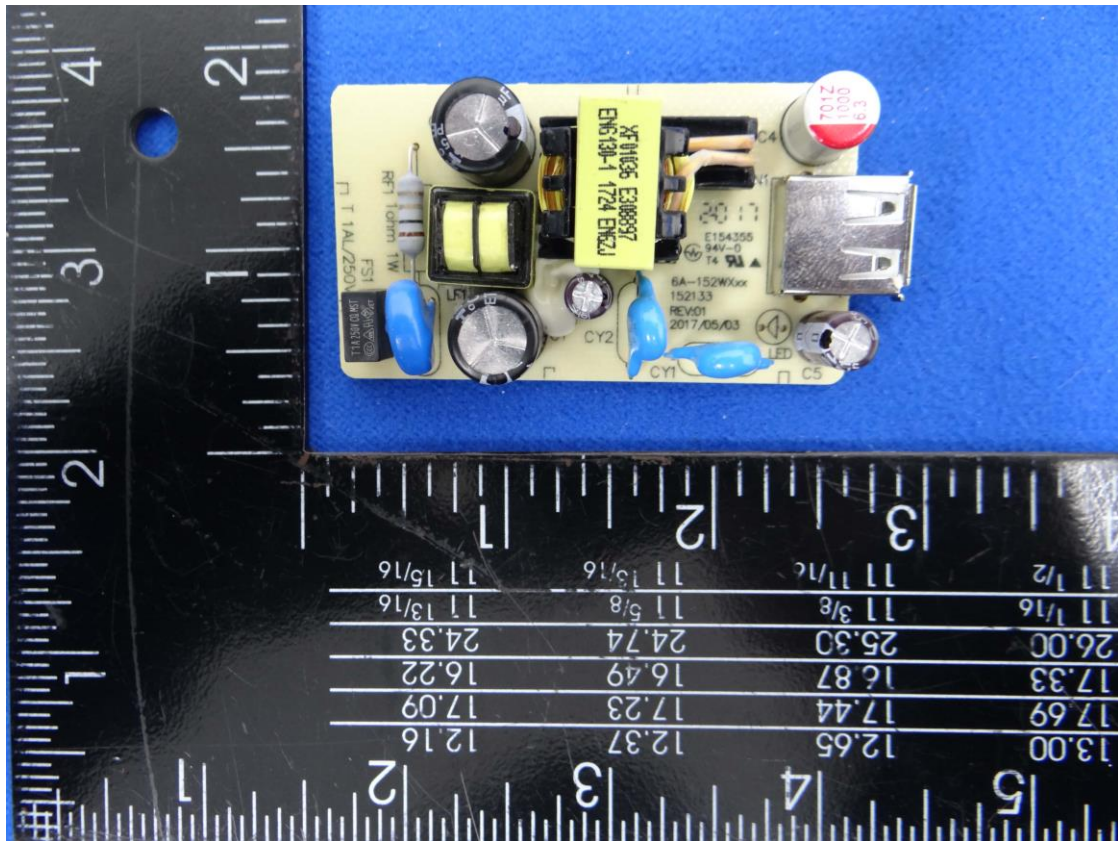

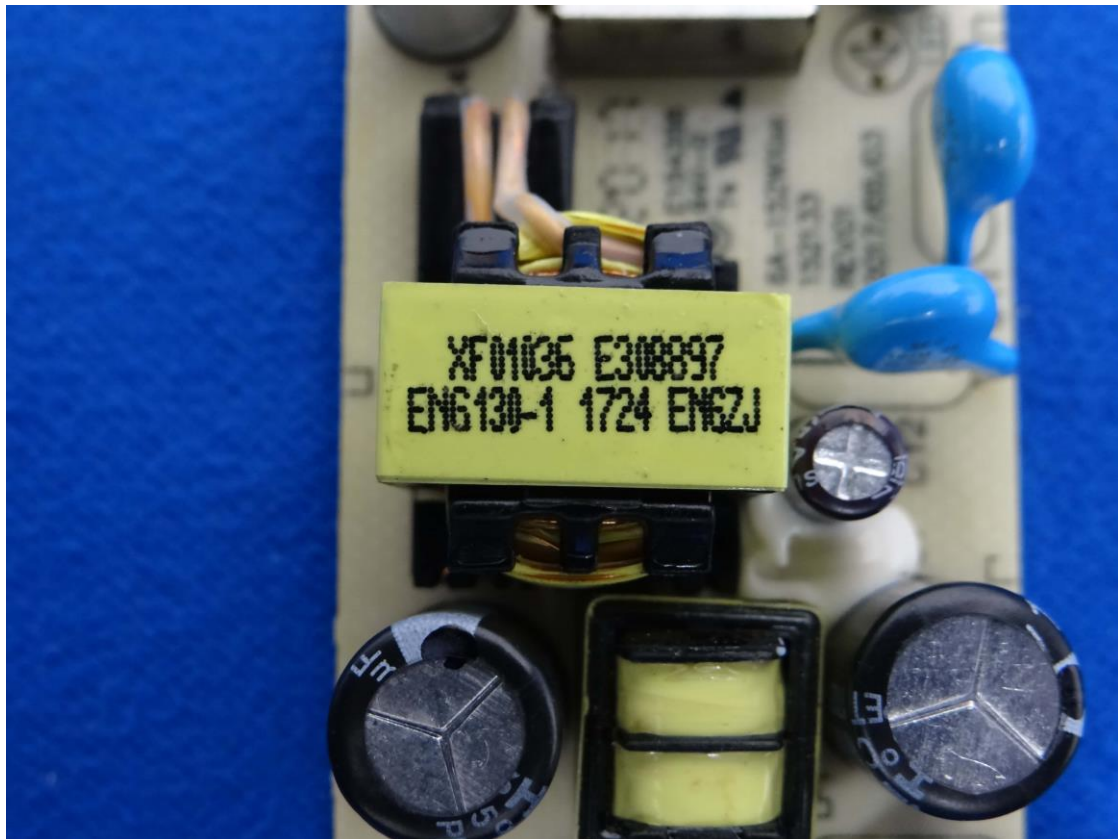
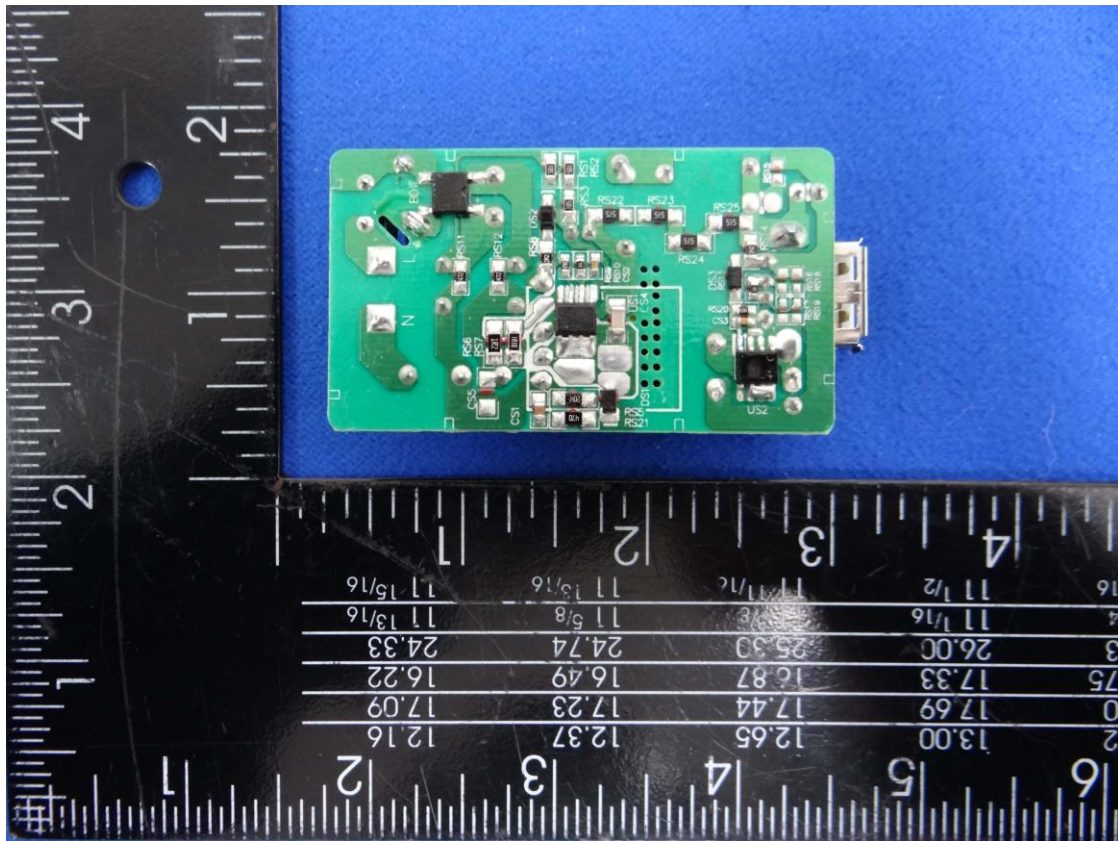



GTM46161-165.0-USB1A

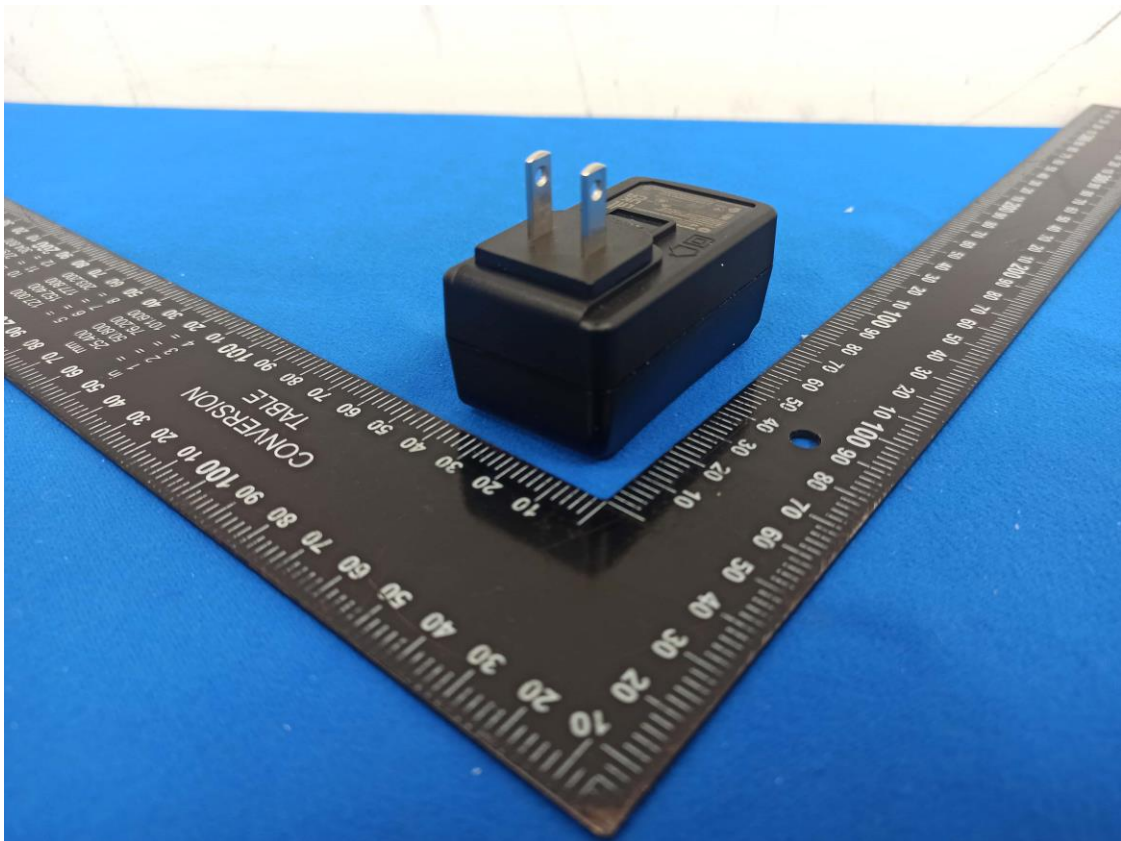
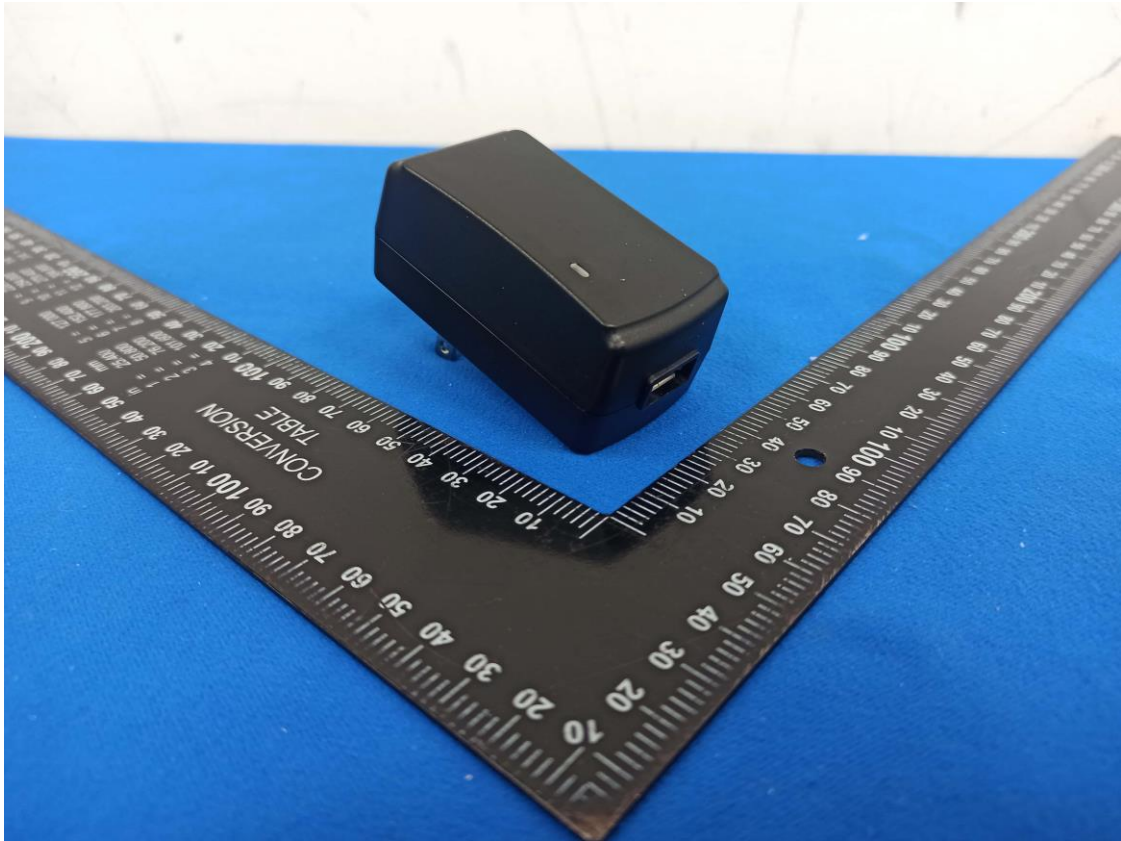



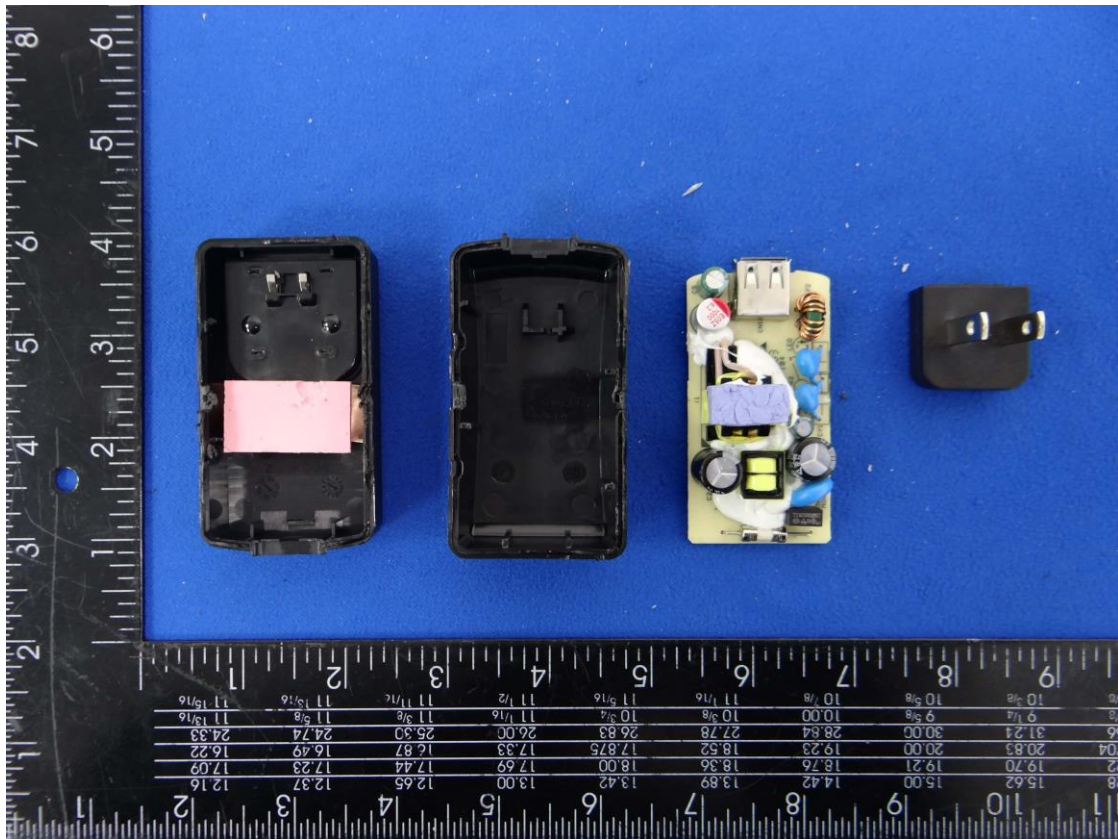

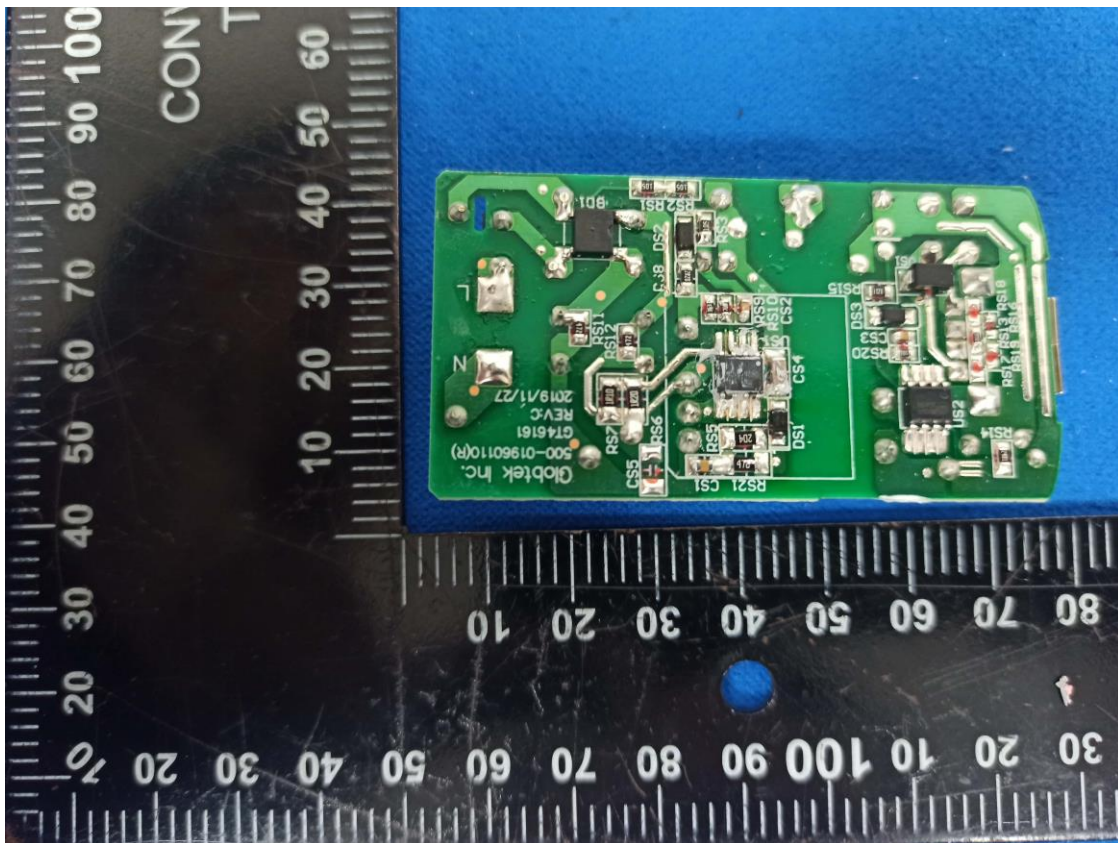
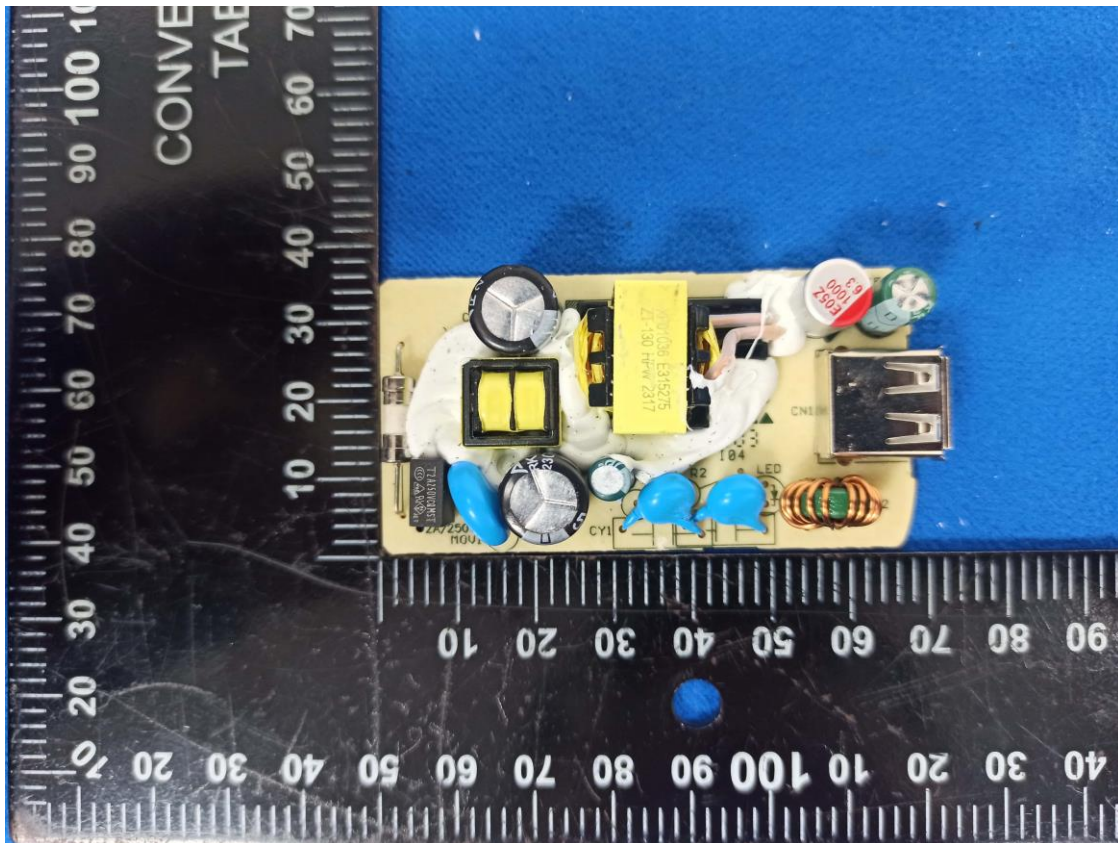

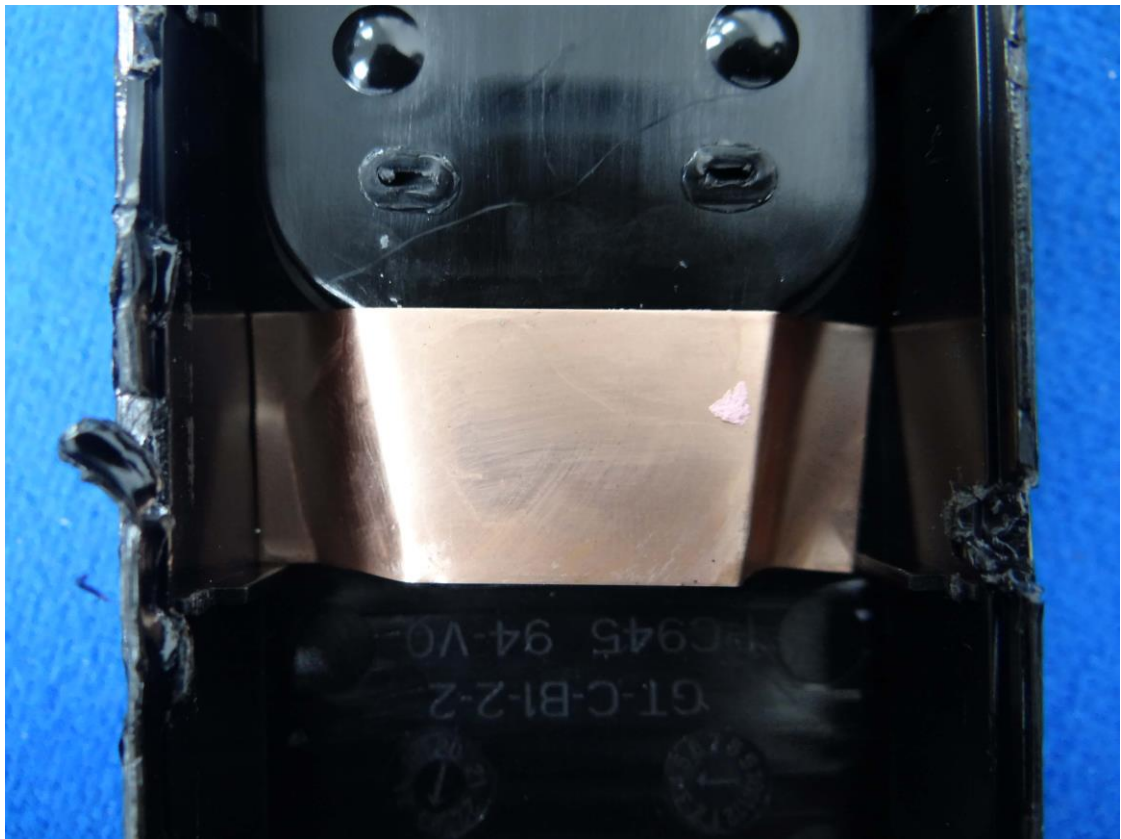
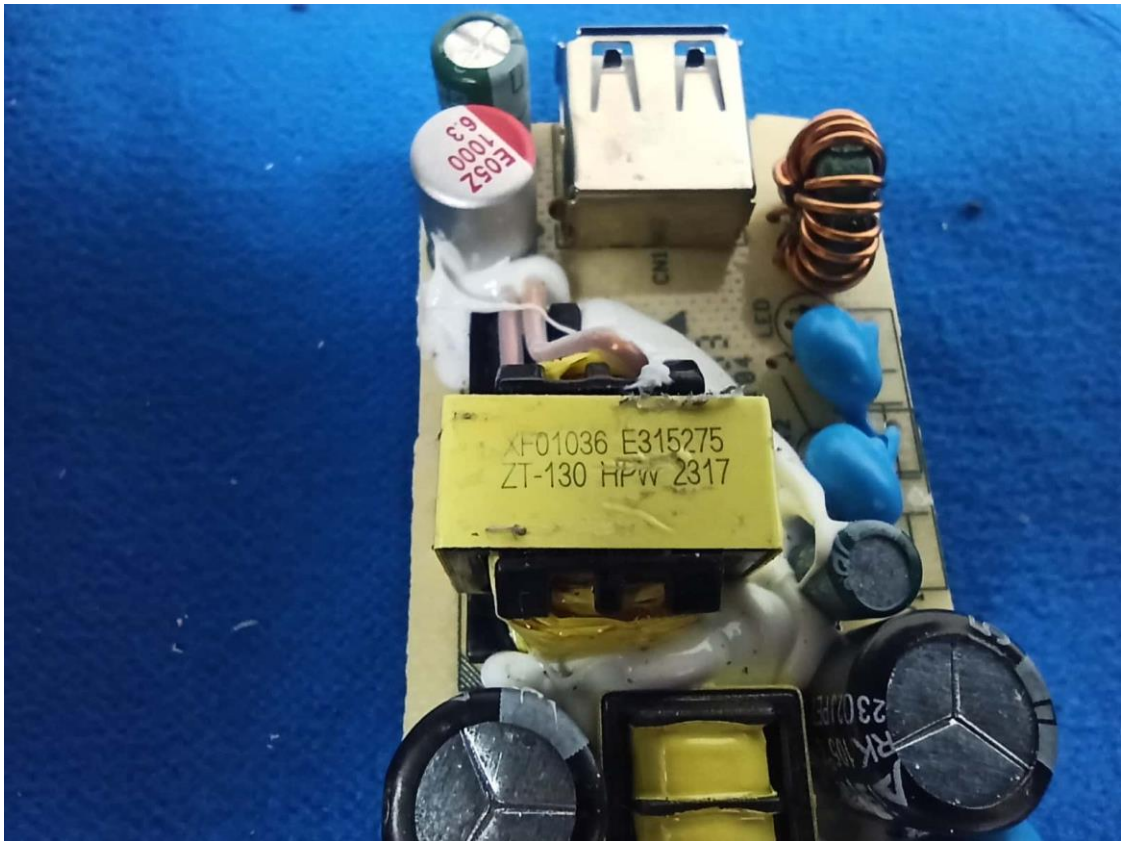



GTM46161-165.0-USB1A1C

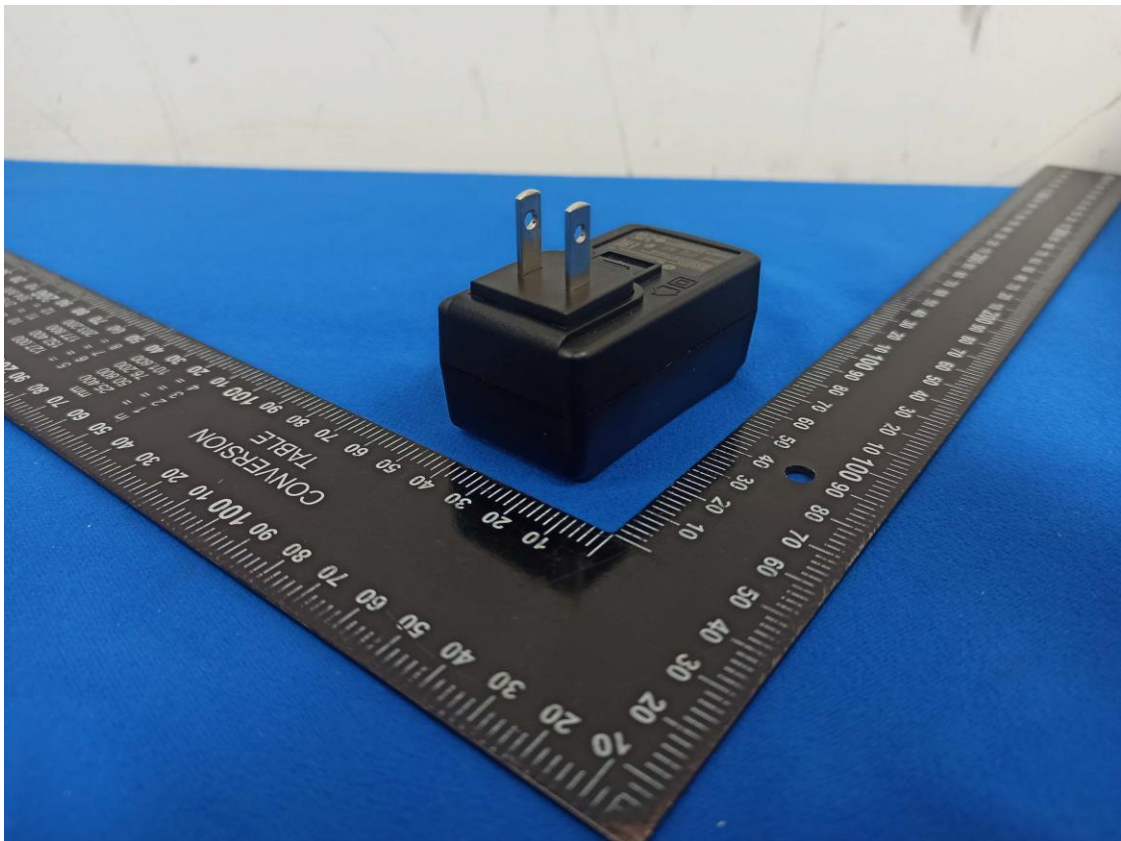
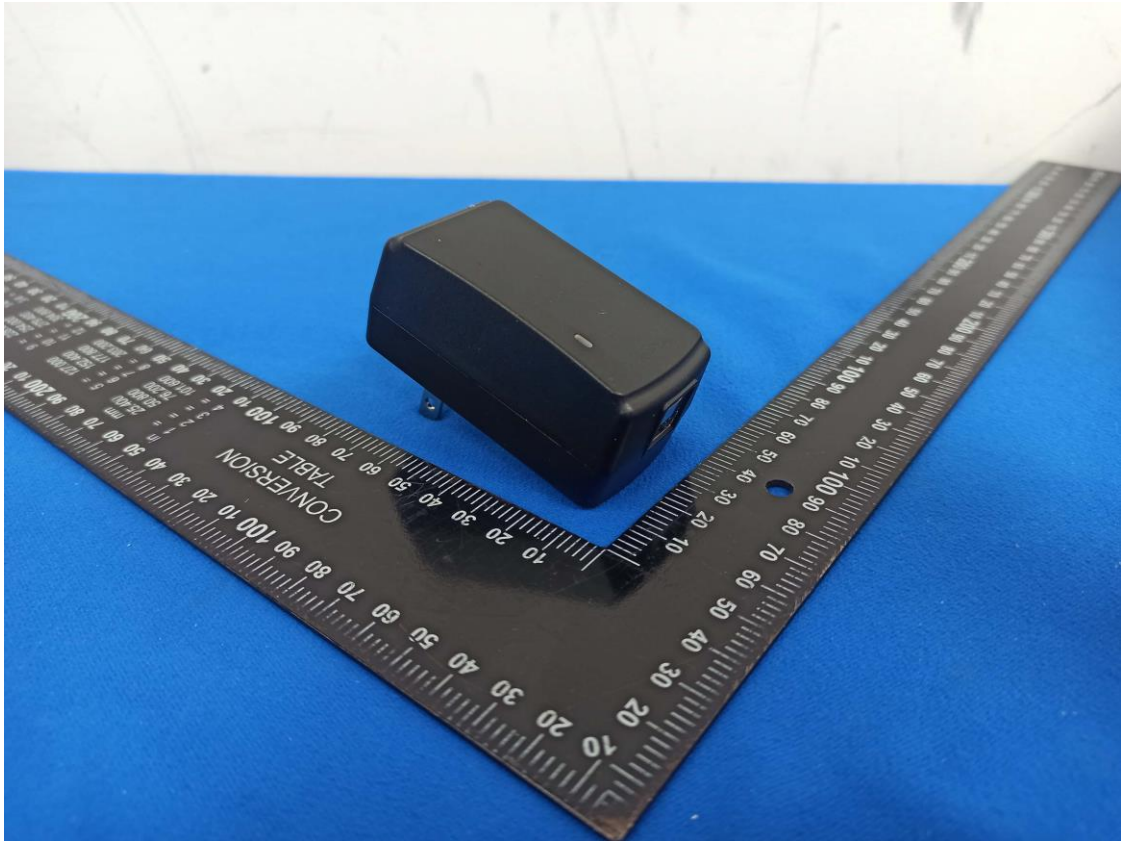





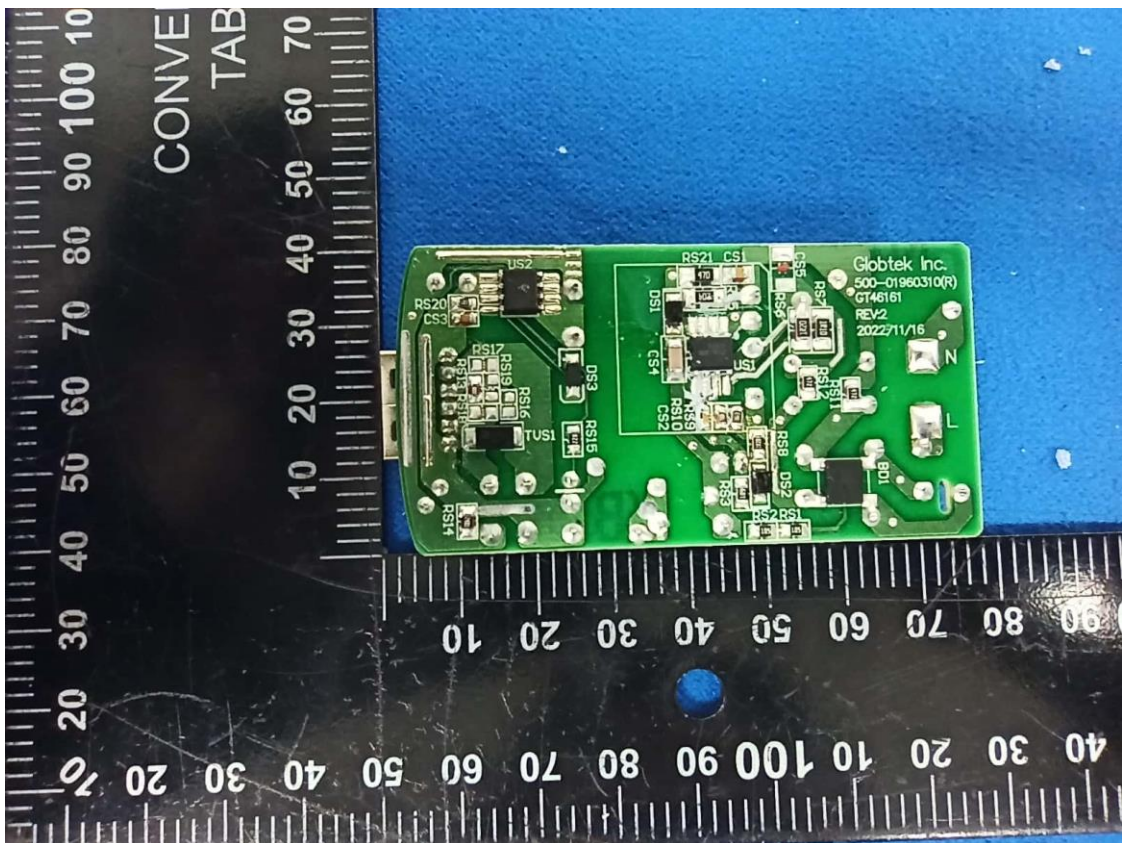
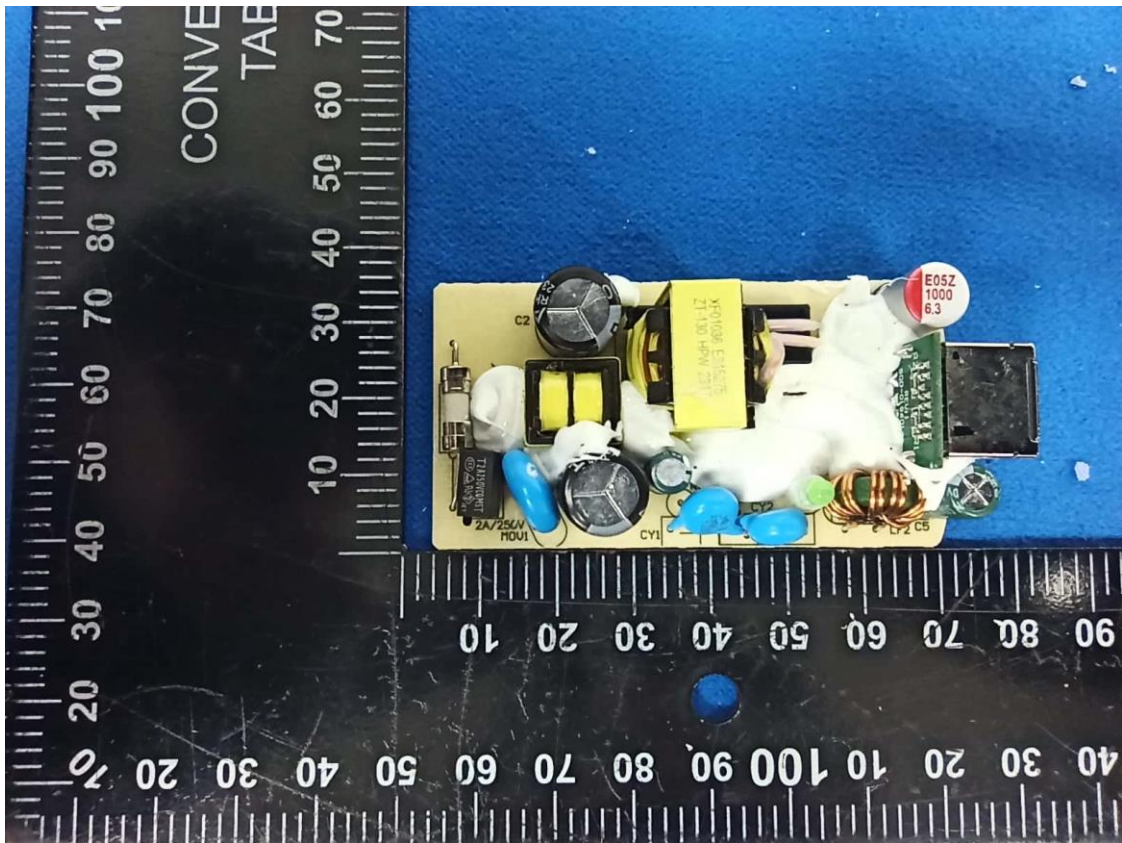





GTM46161-165.0-USB2A

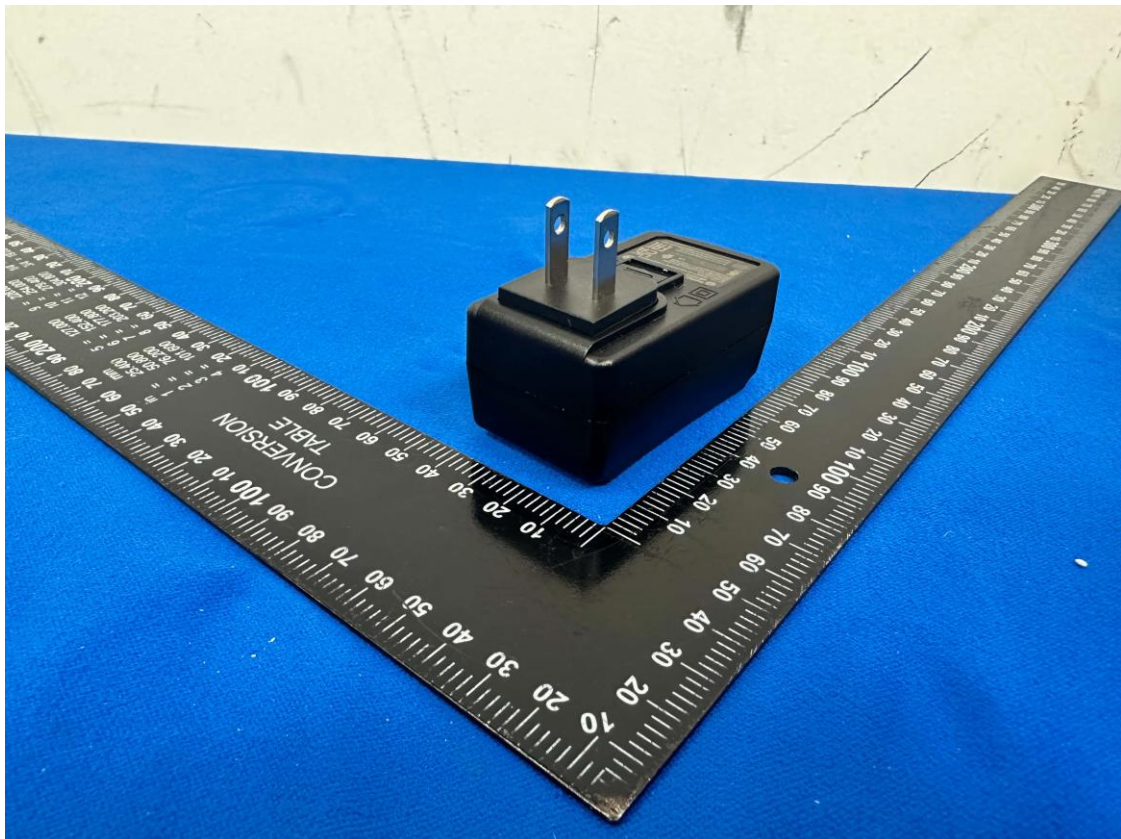



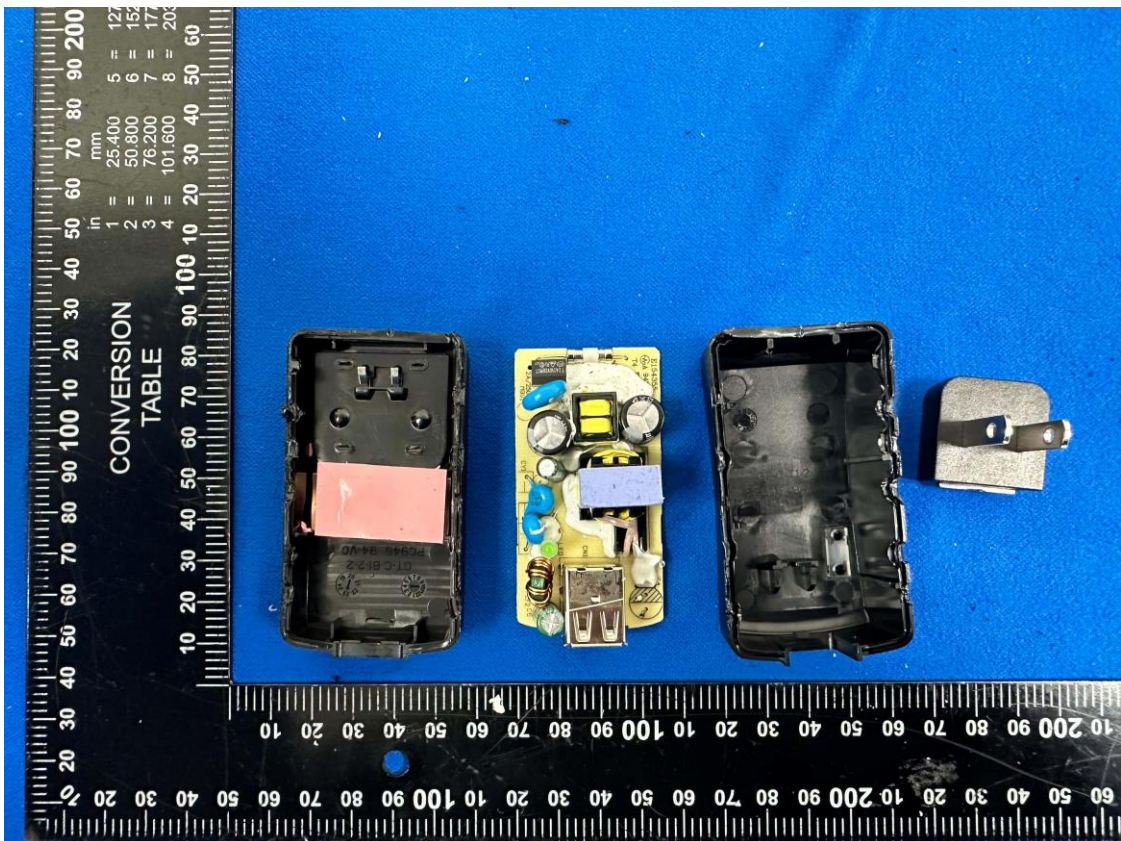

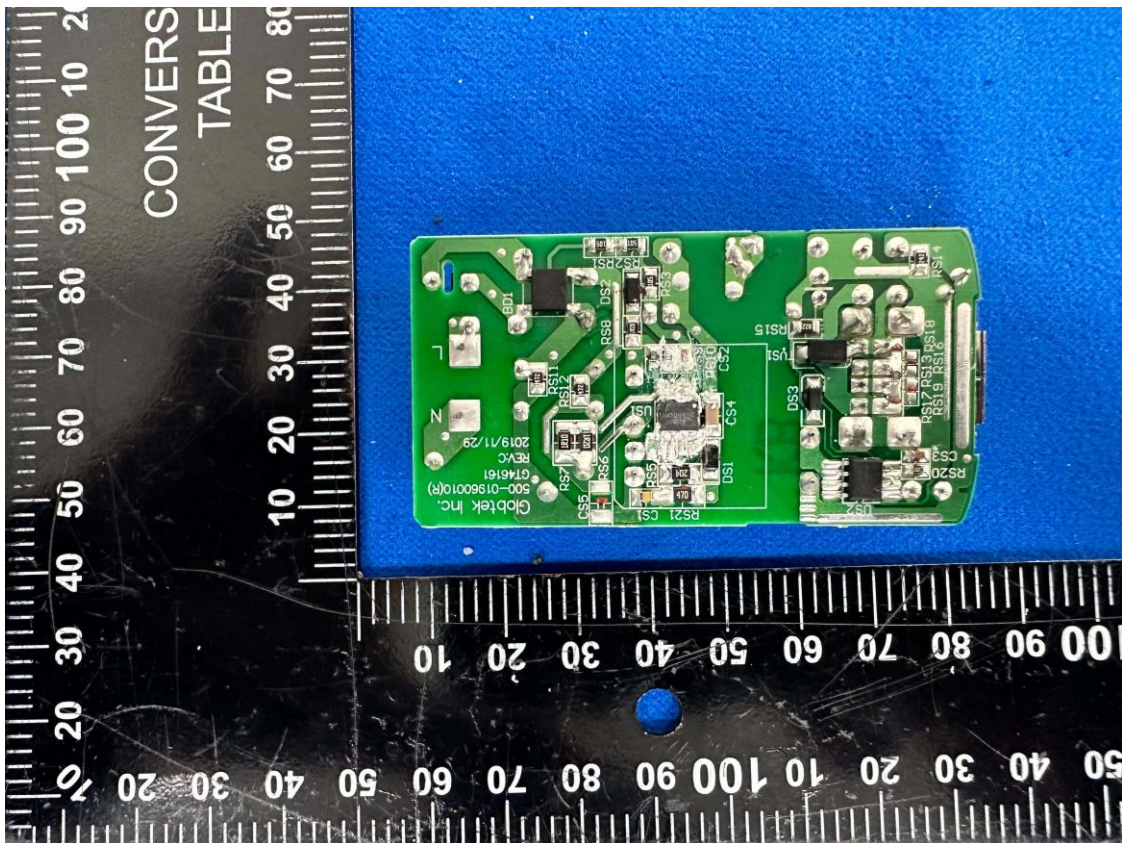
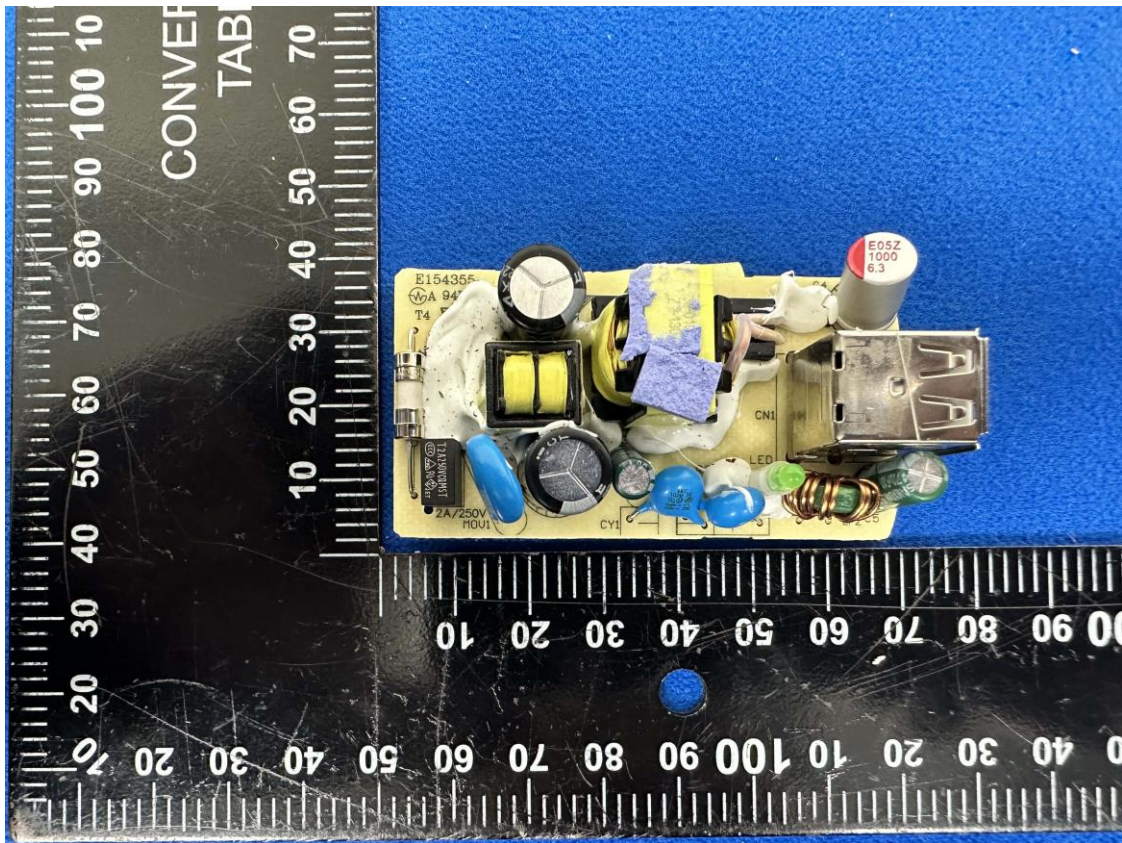

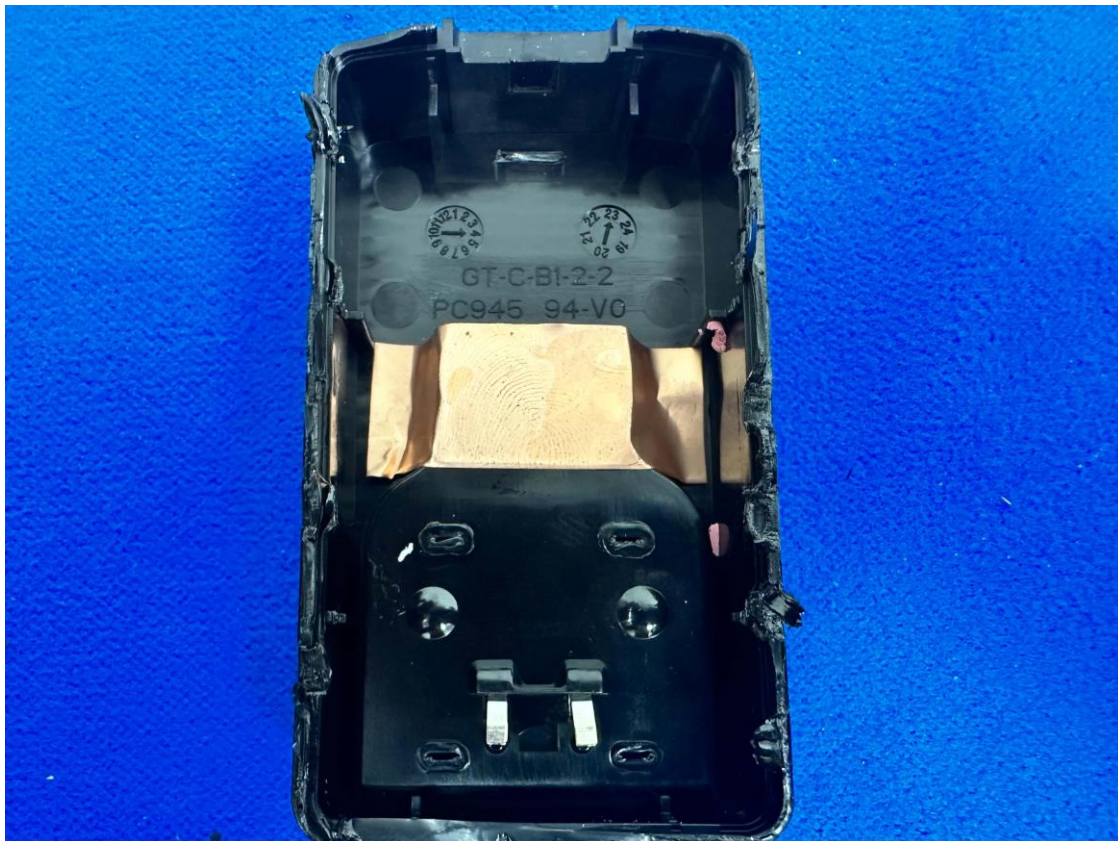
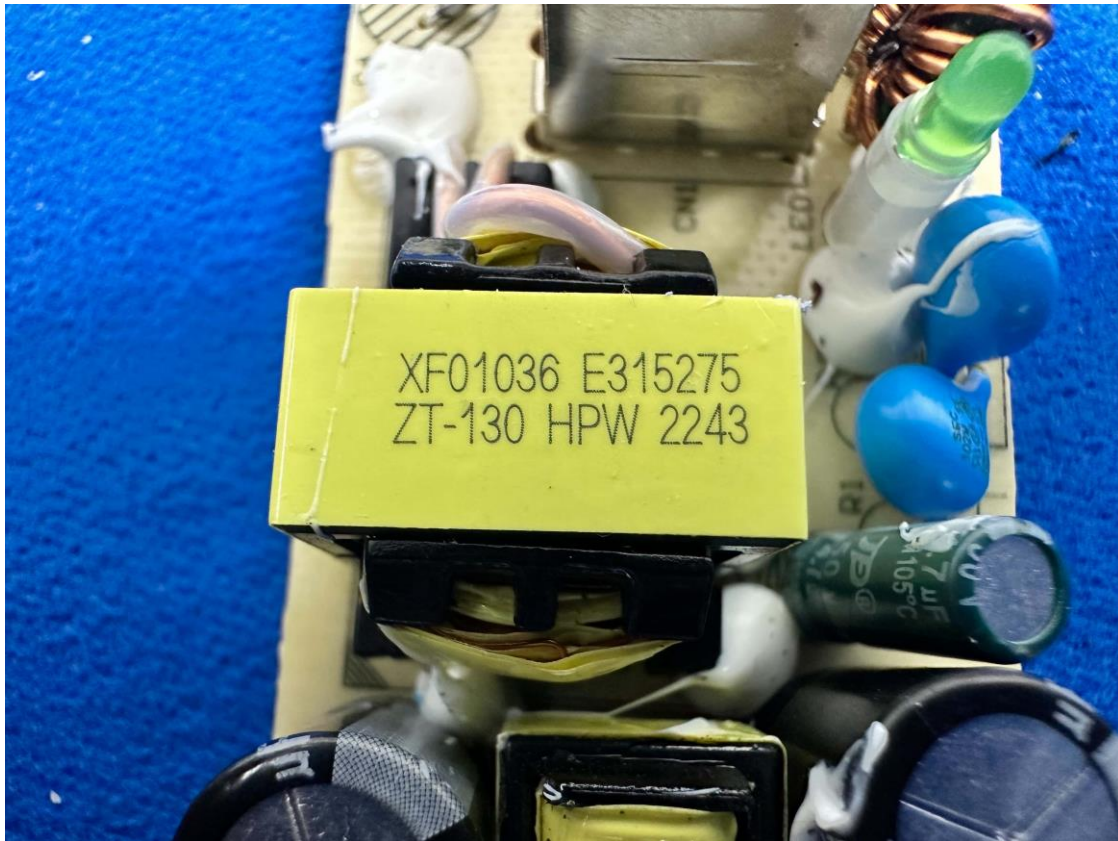



GTM46161-165.0-USB2C

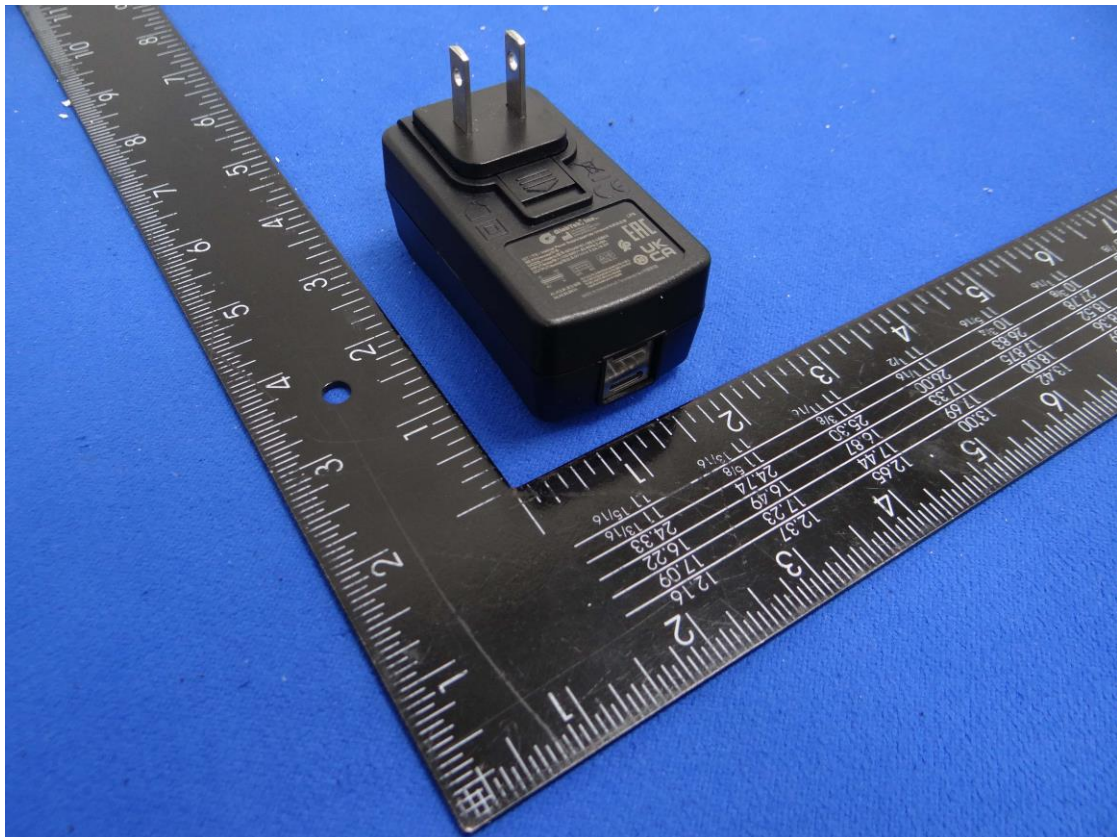
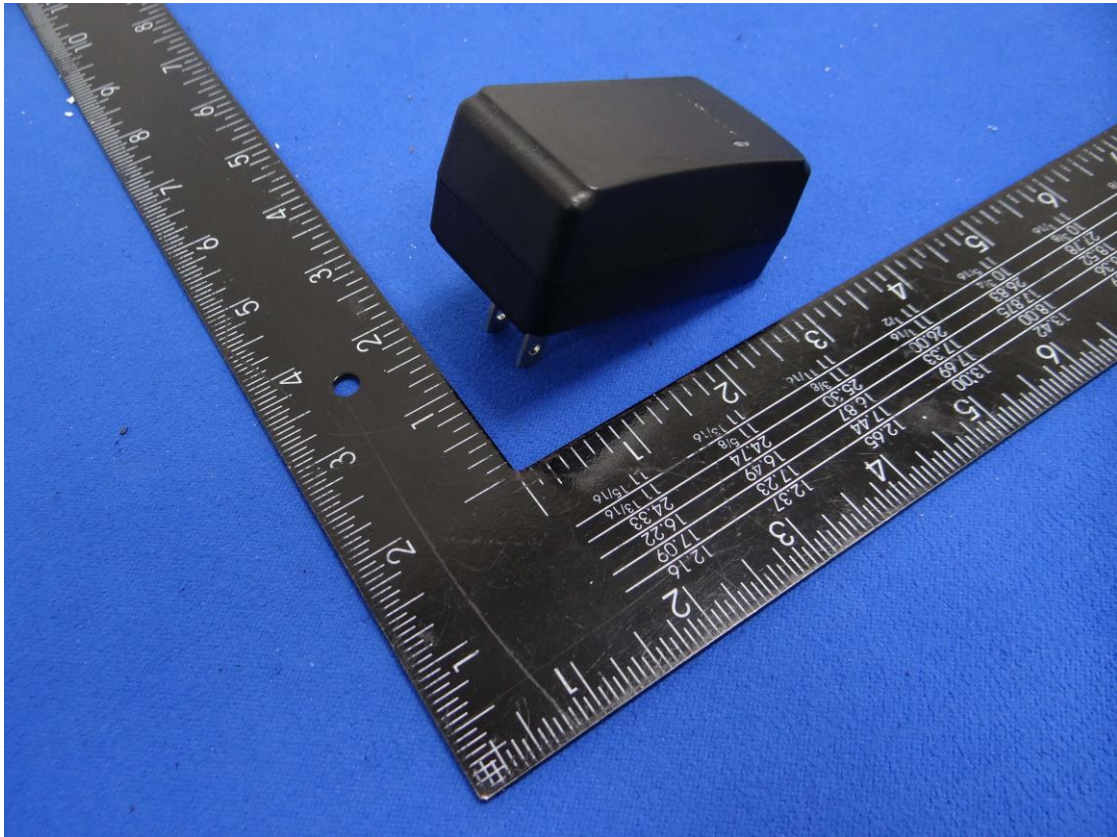



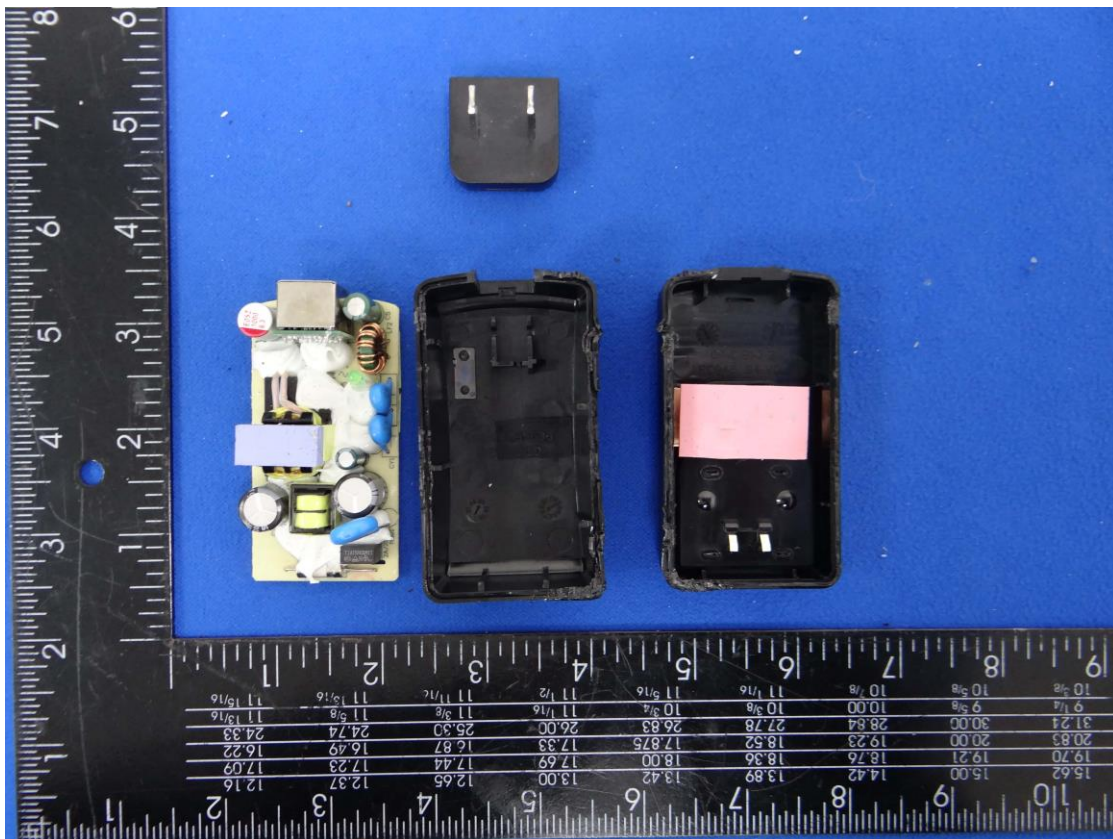

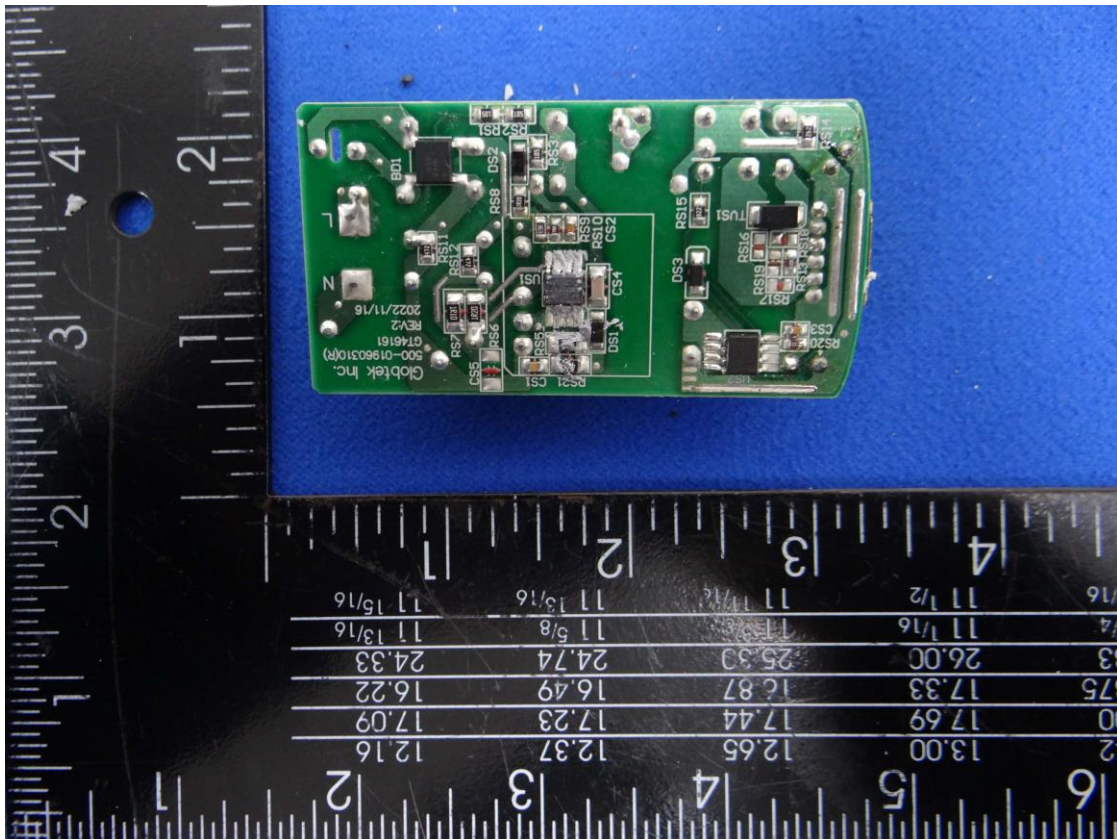
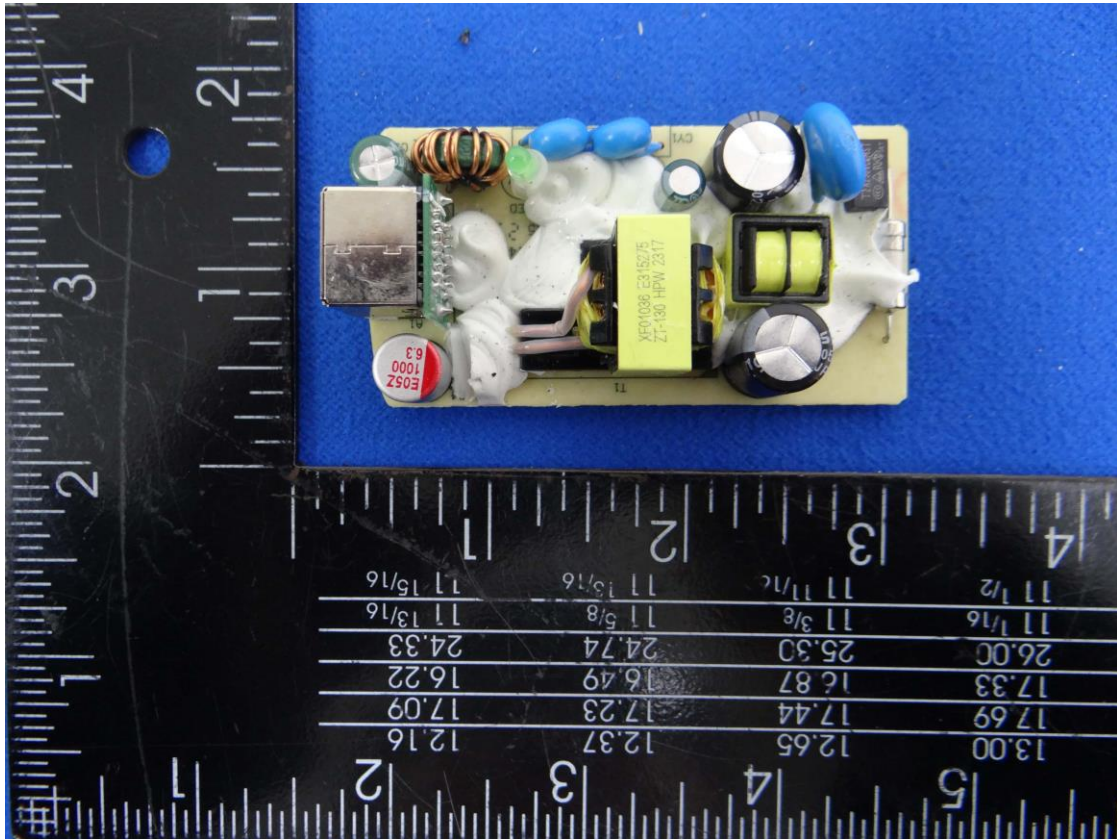





GTM46161-165.0-USBC

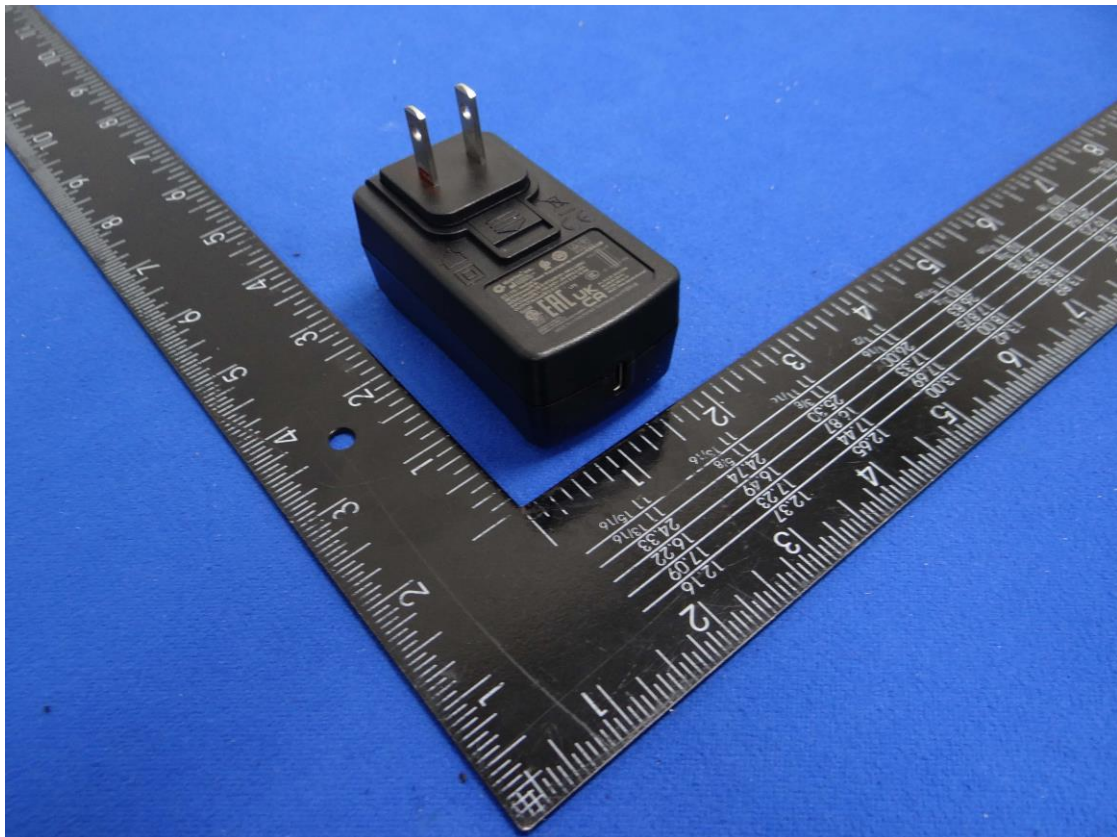
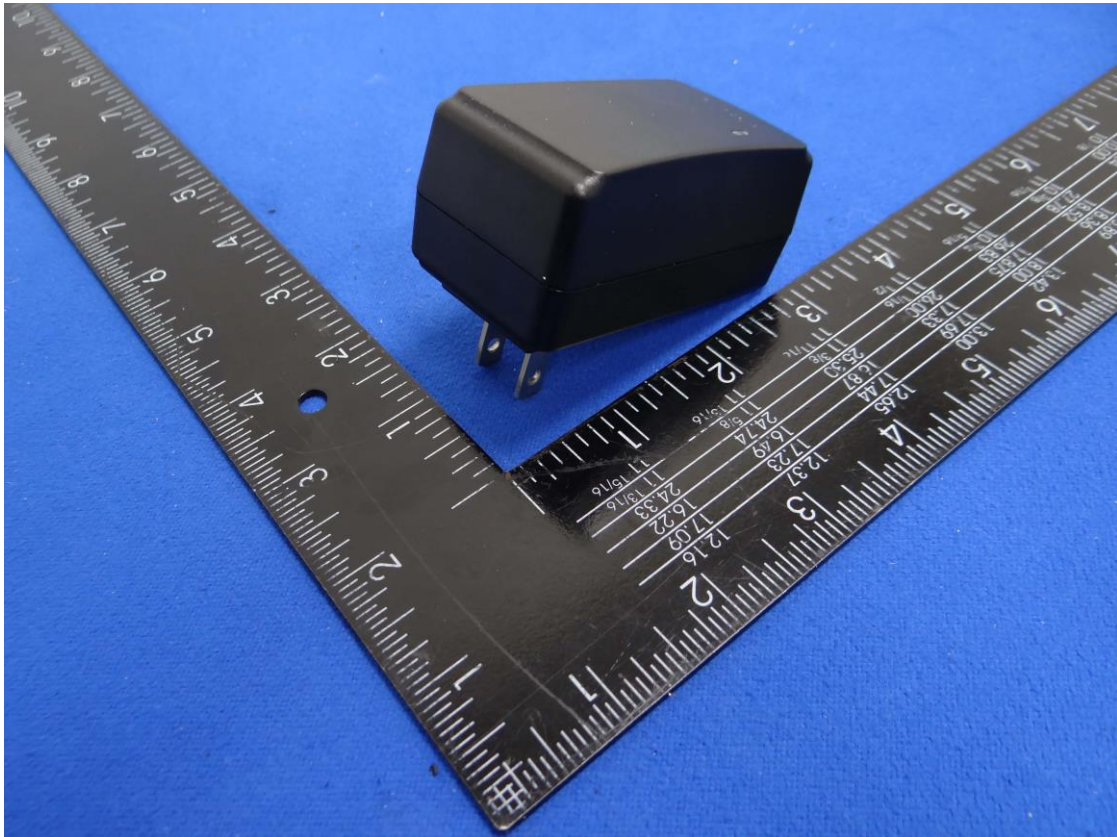





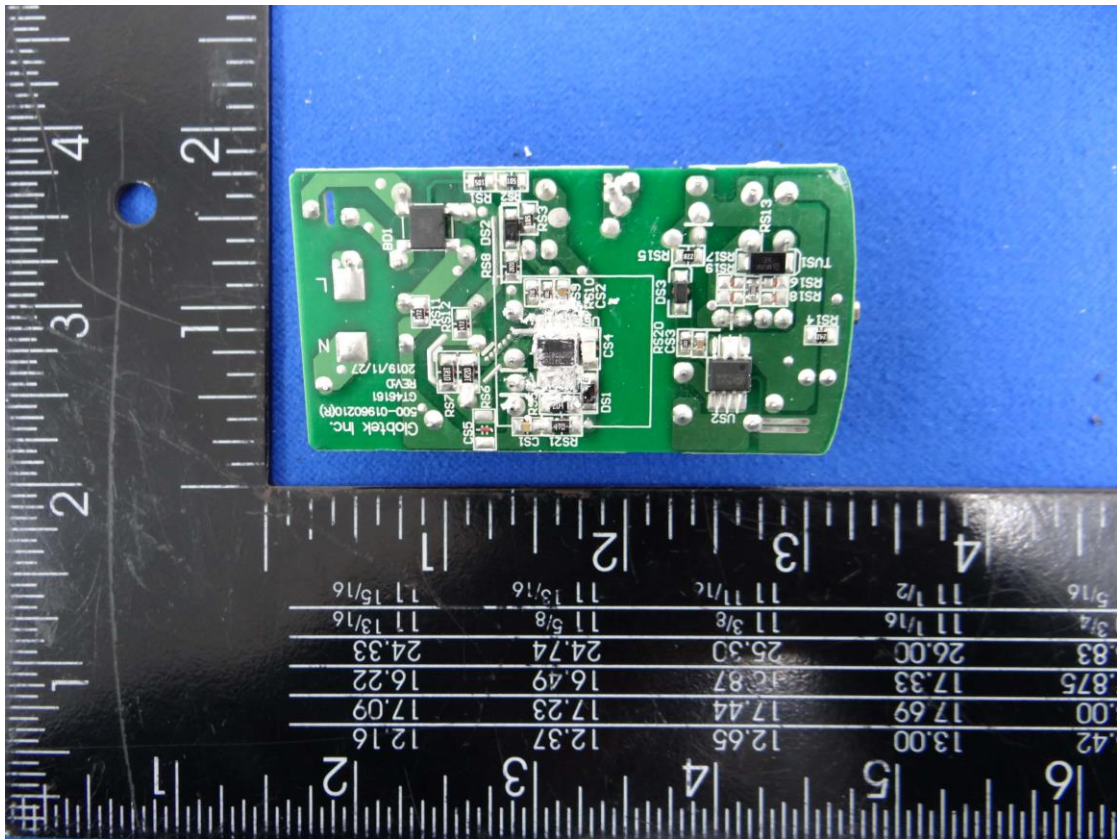
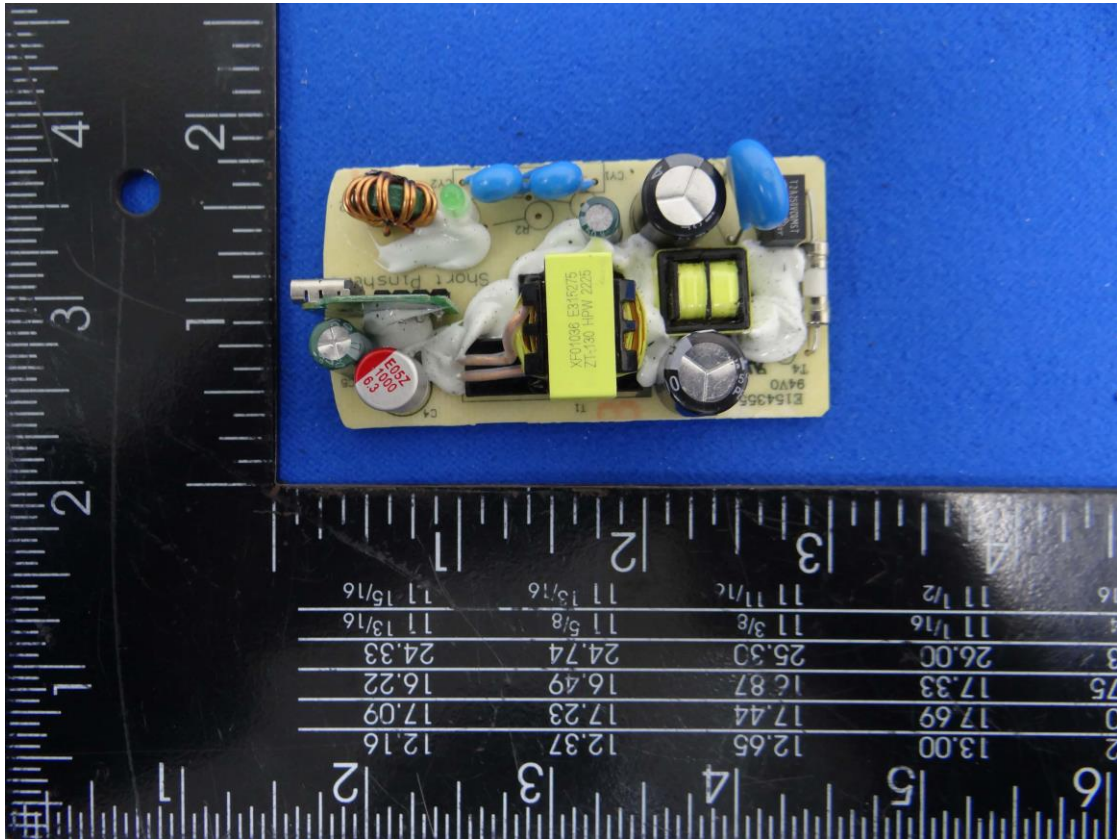

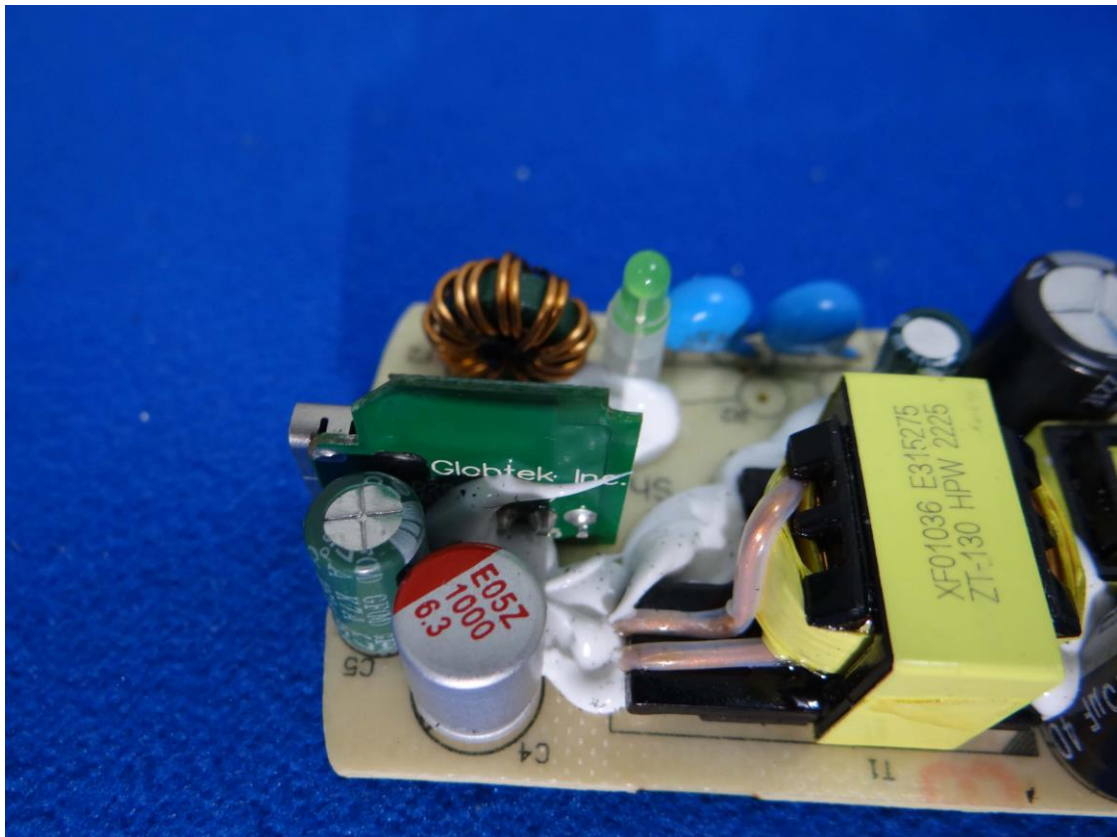
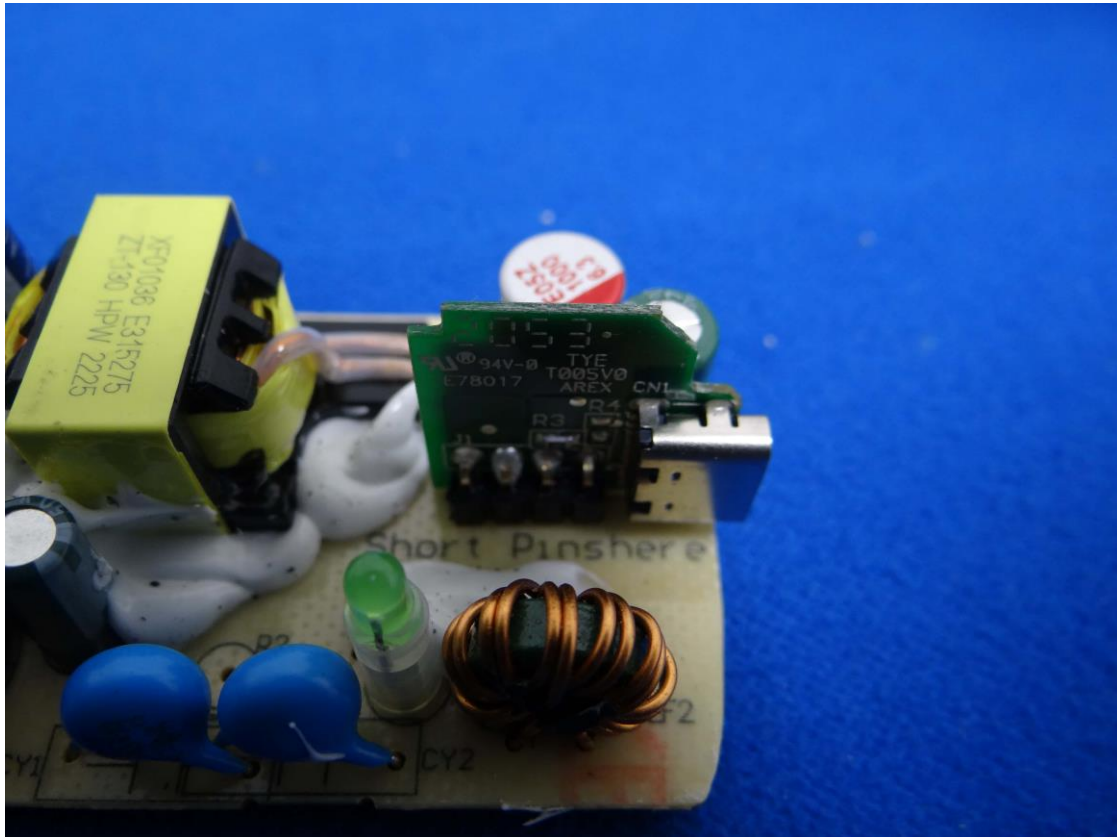





GTM46161-165.5-USB

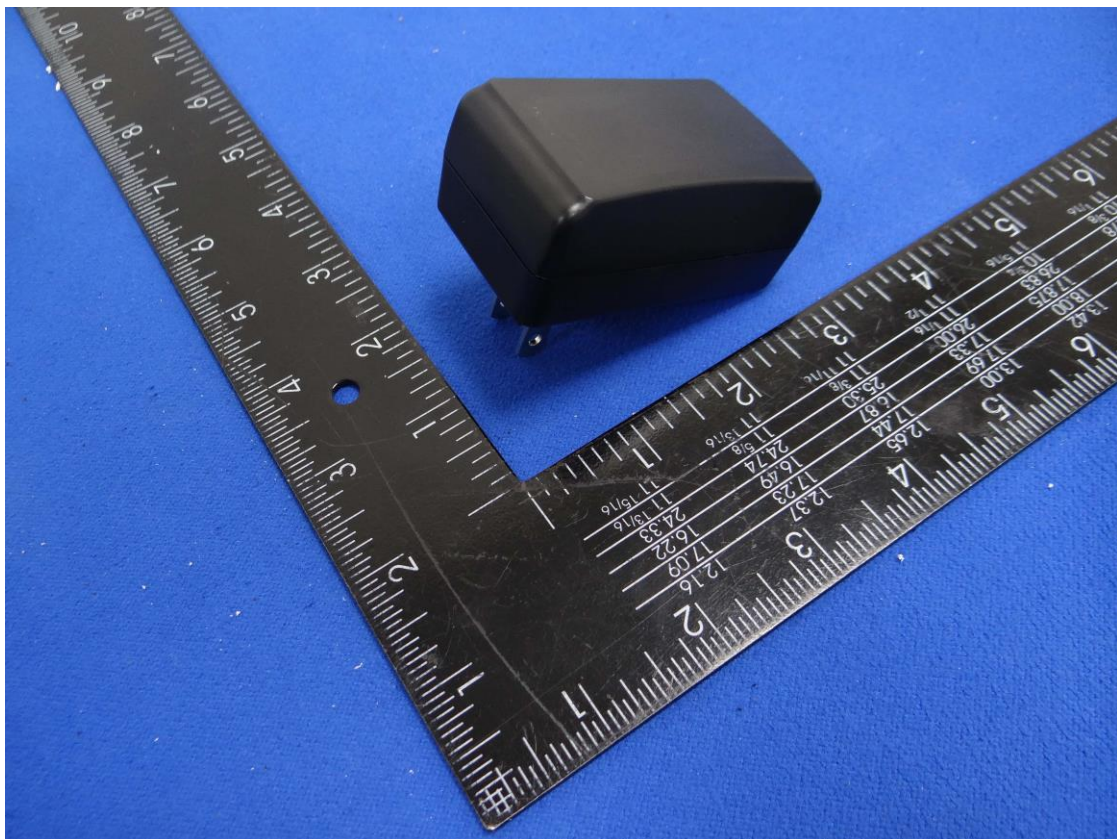
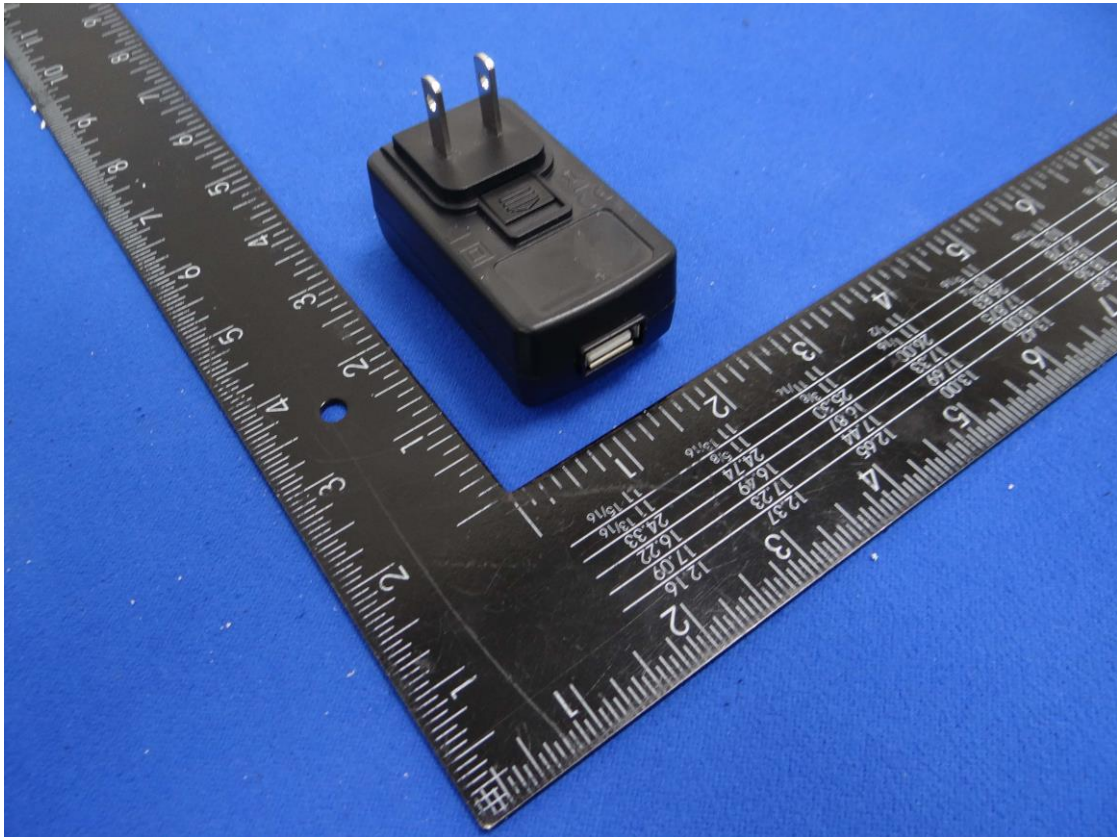



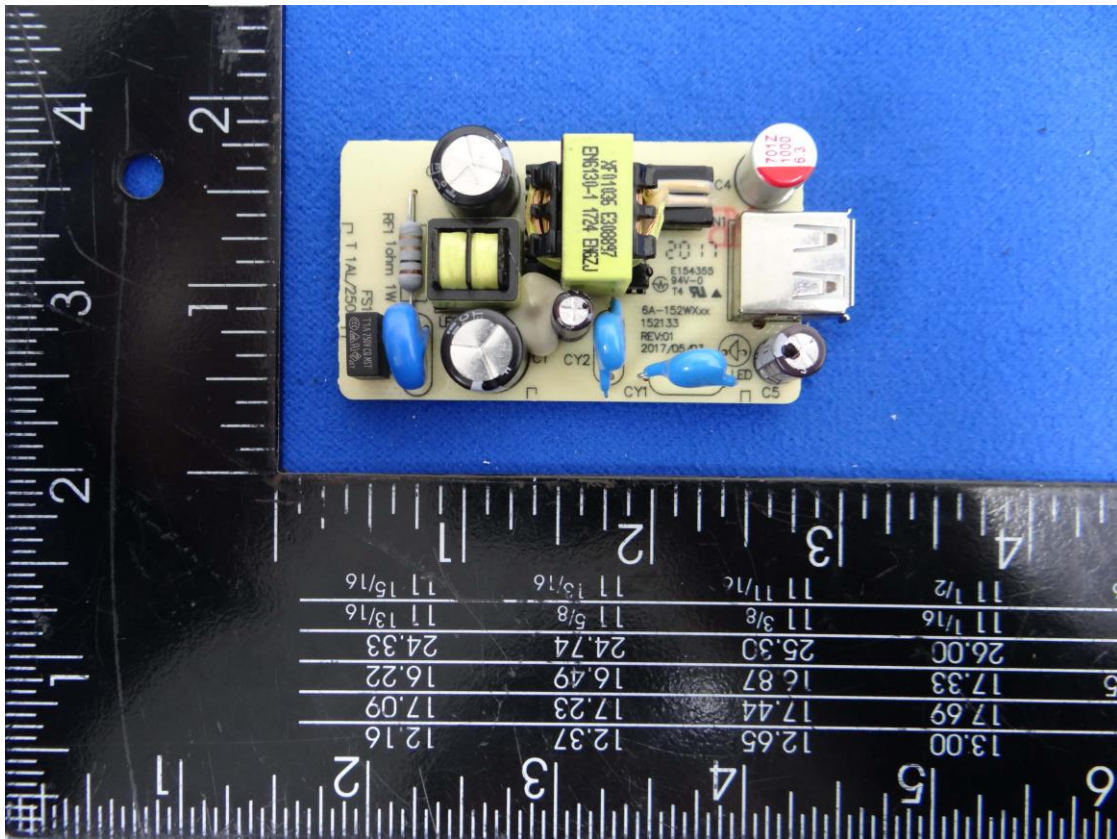
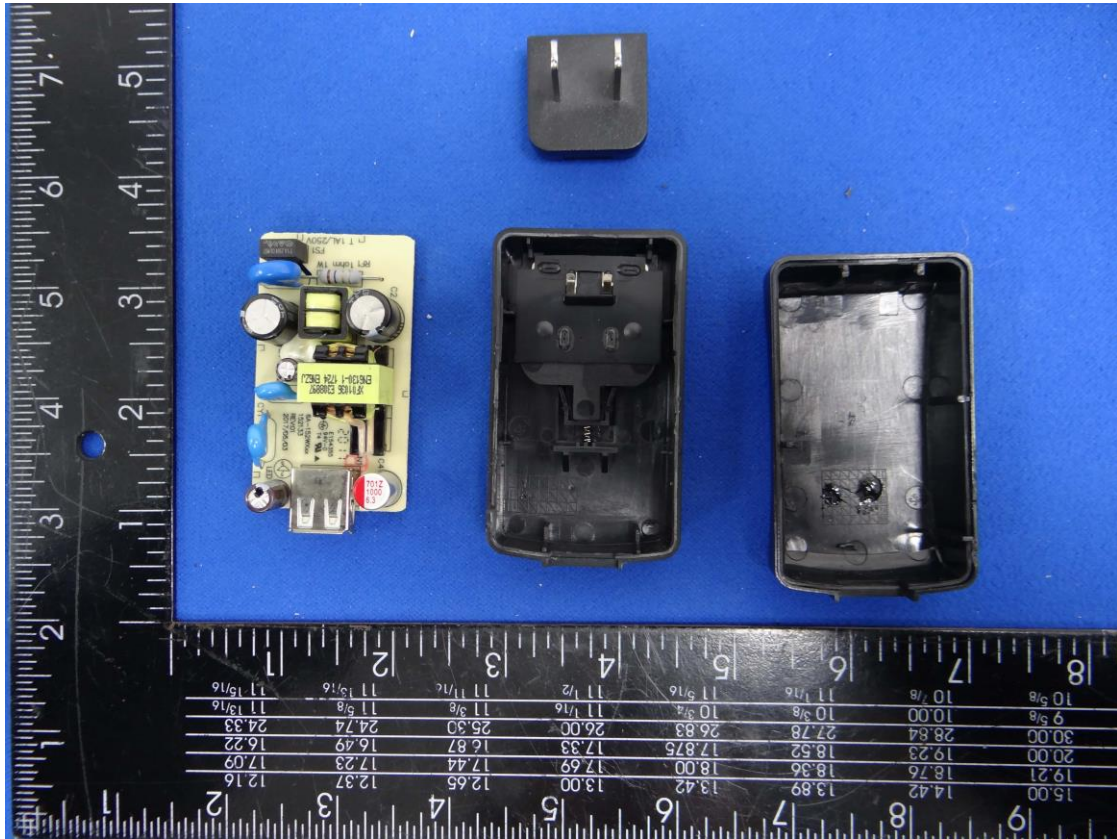

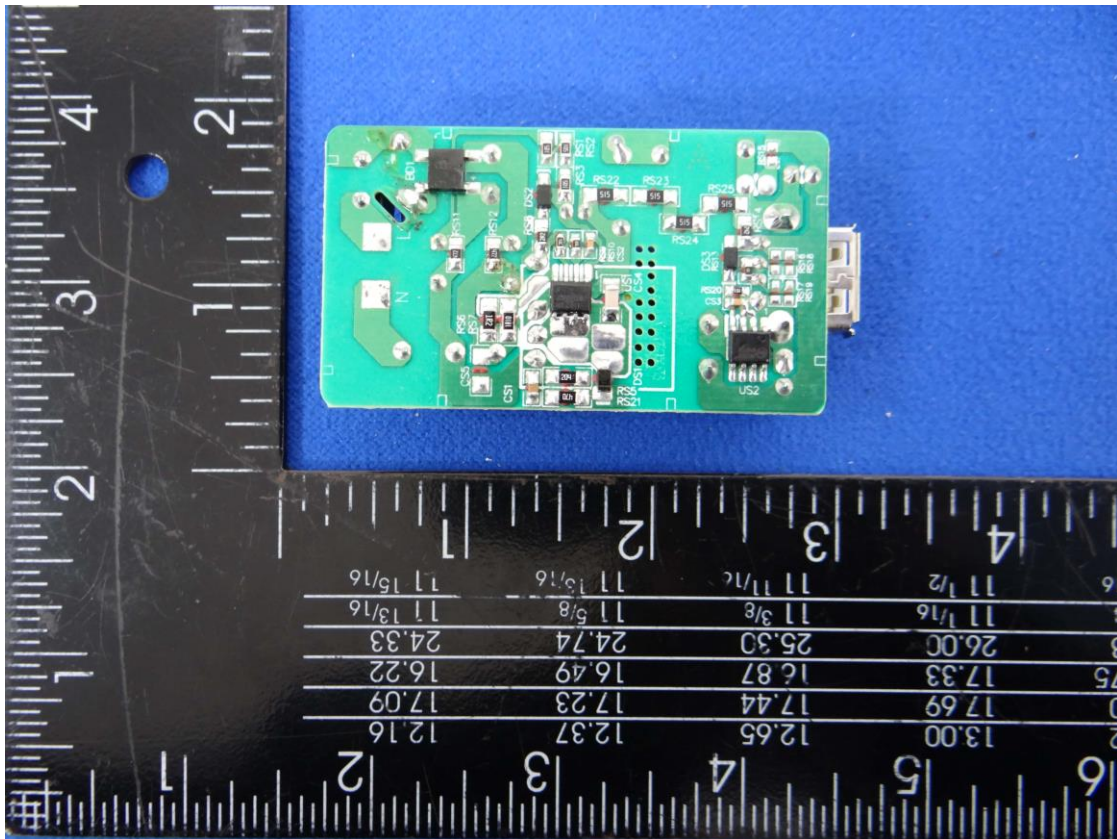



GTM46161-165.5-USB1A

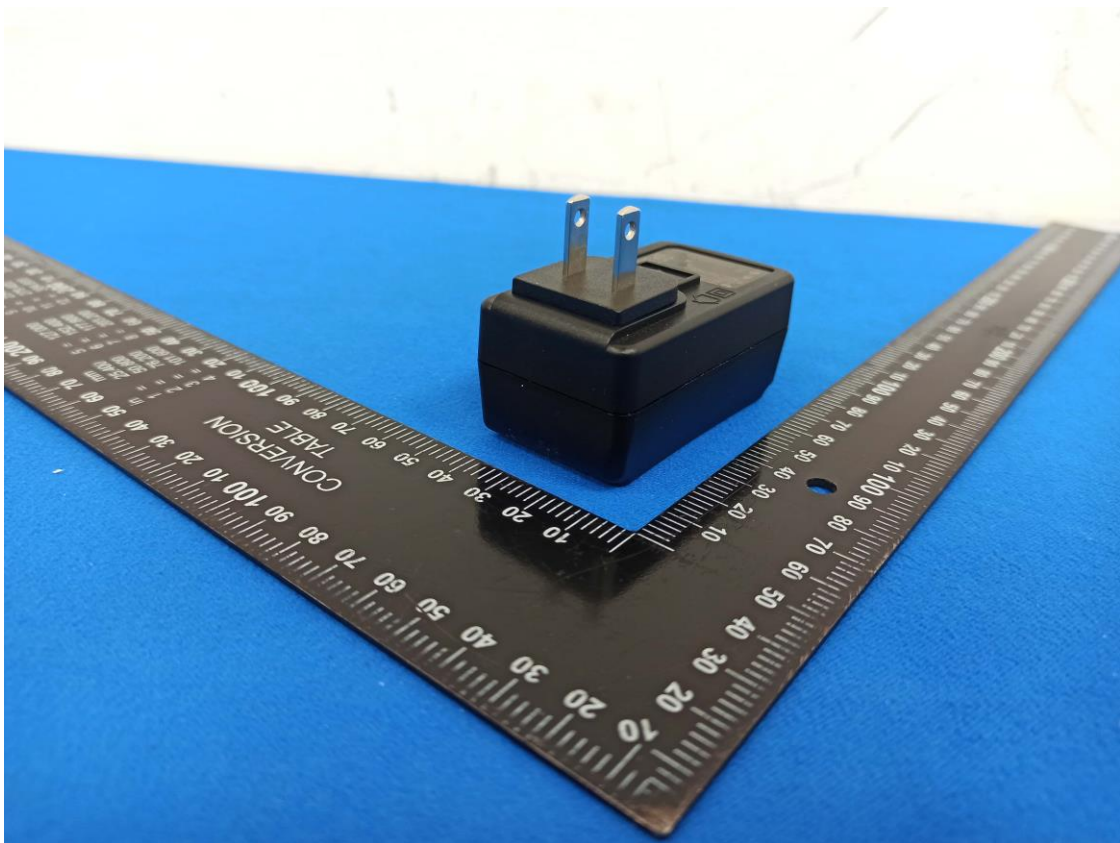
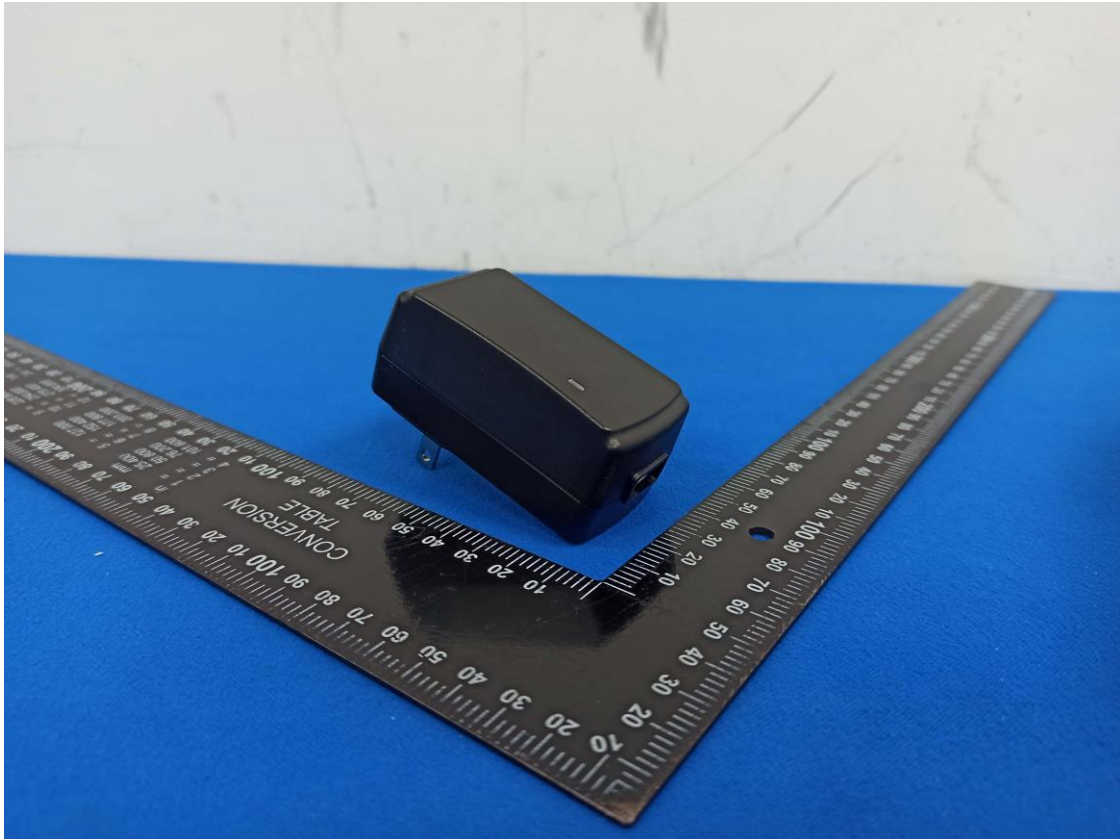

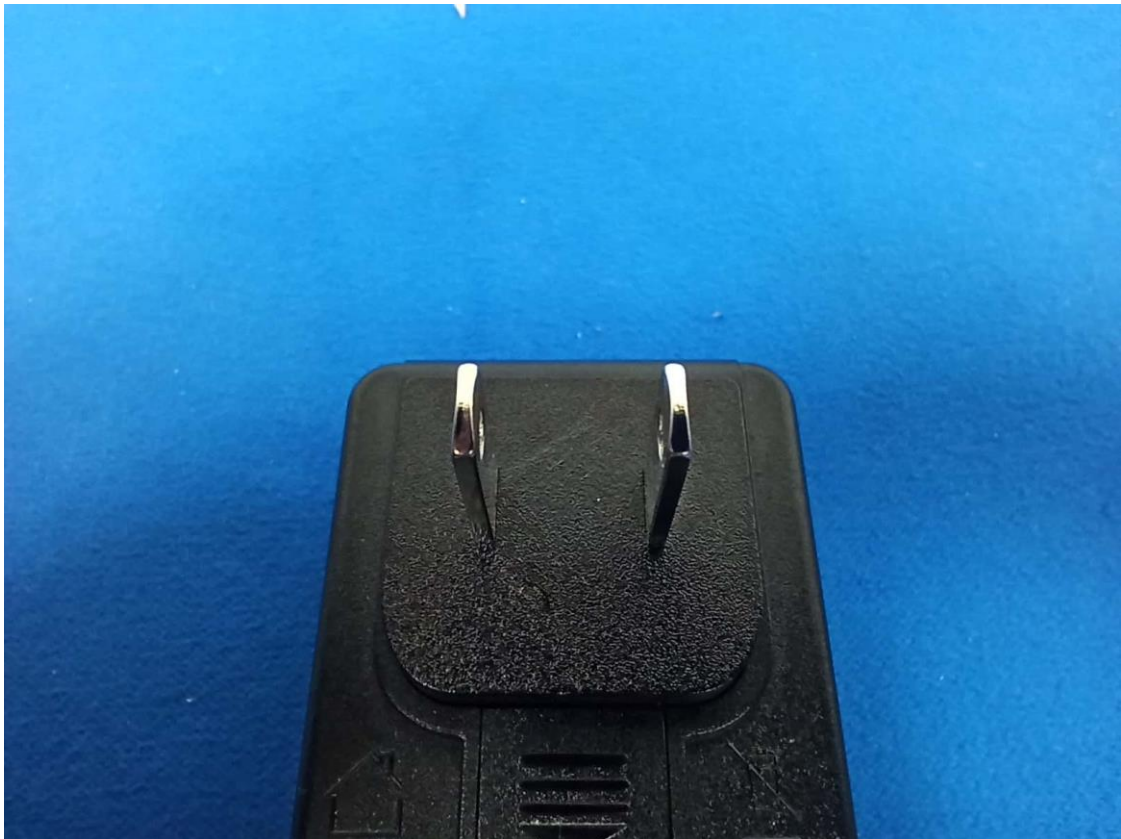



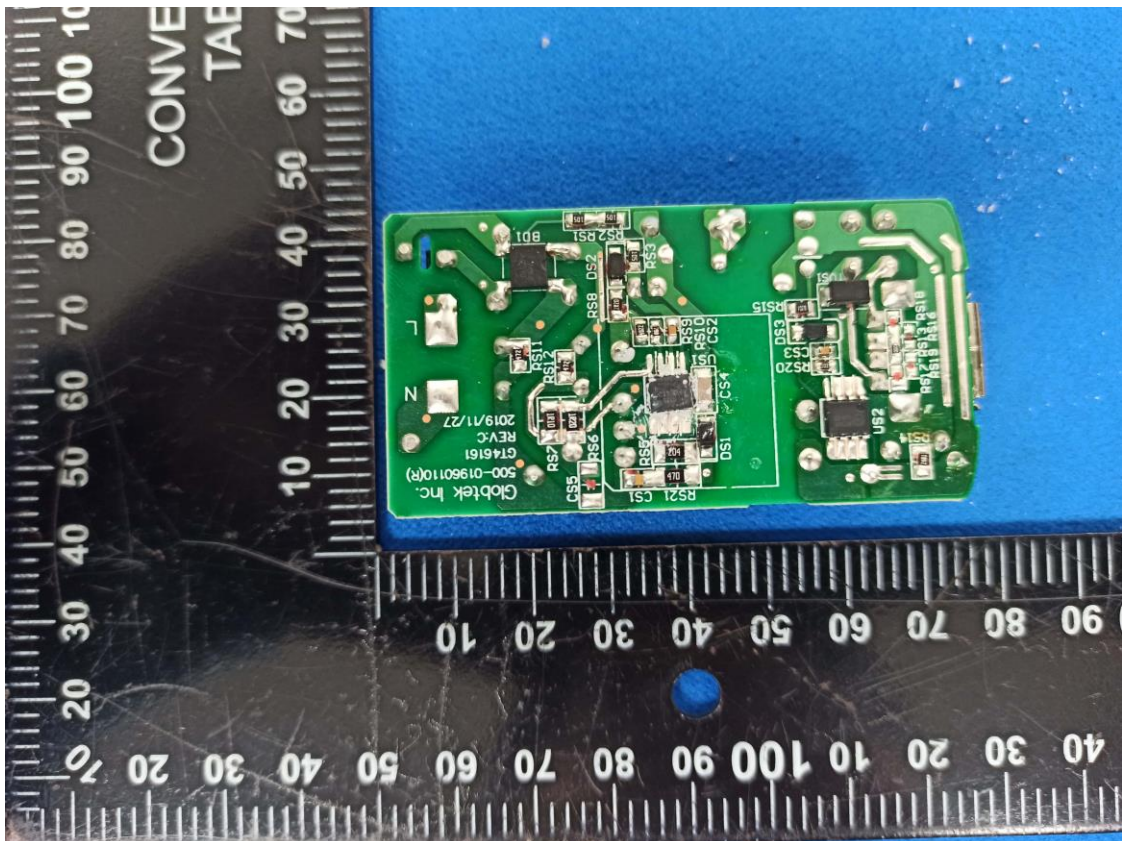
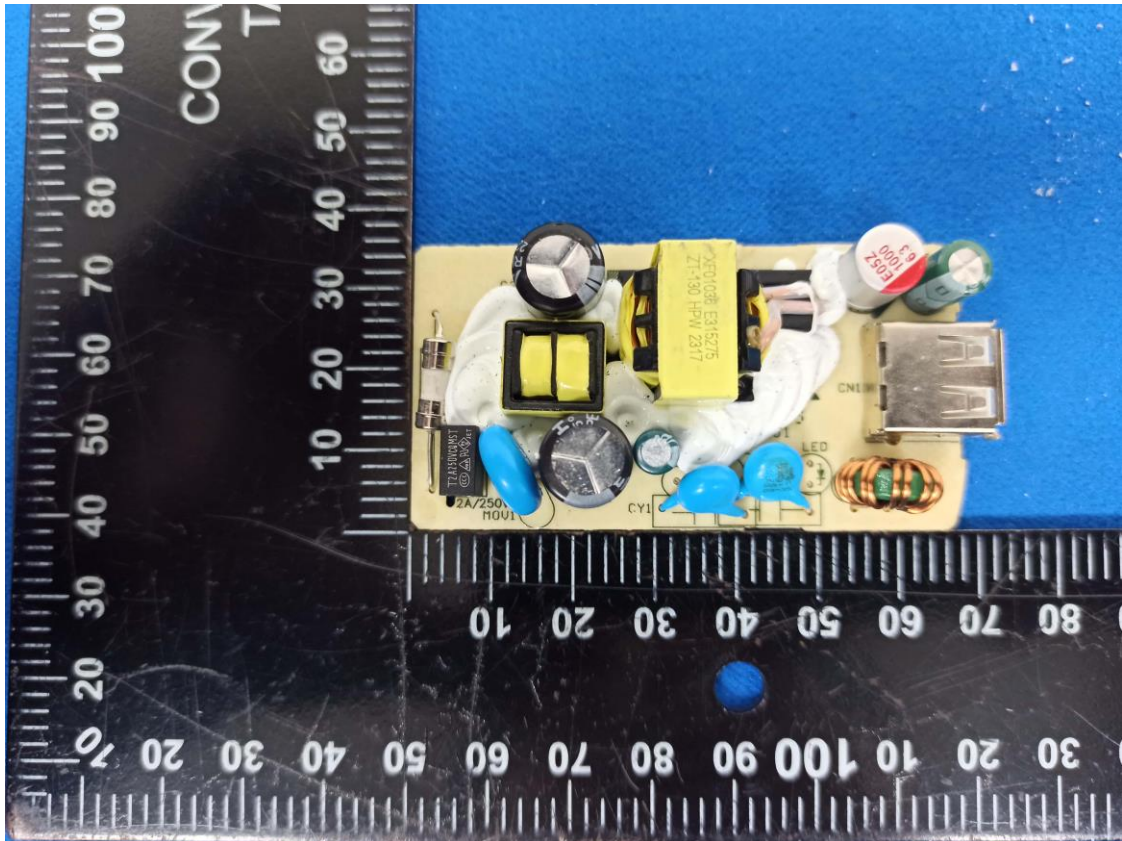

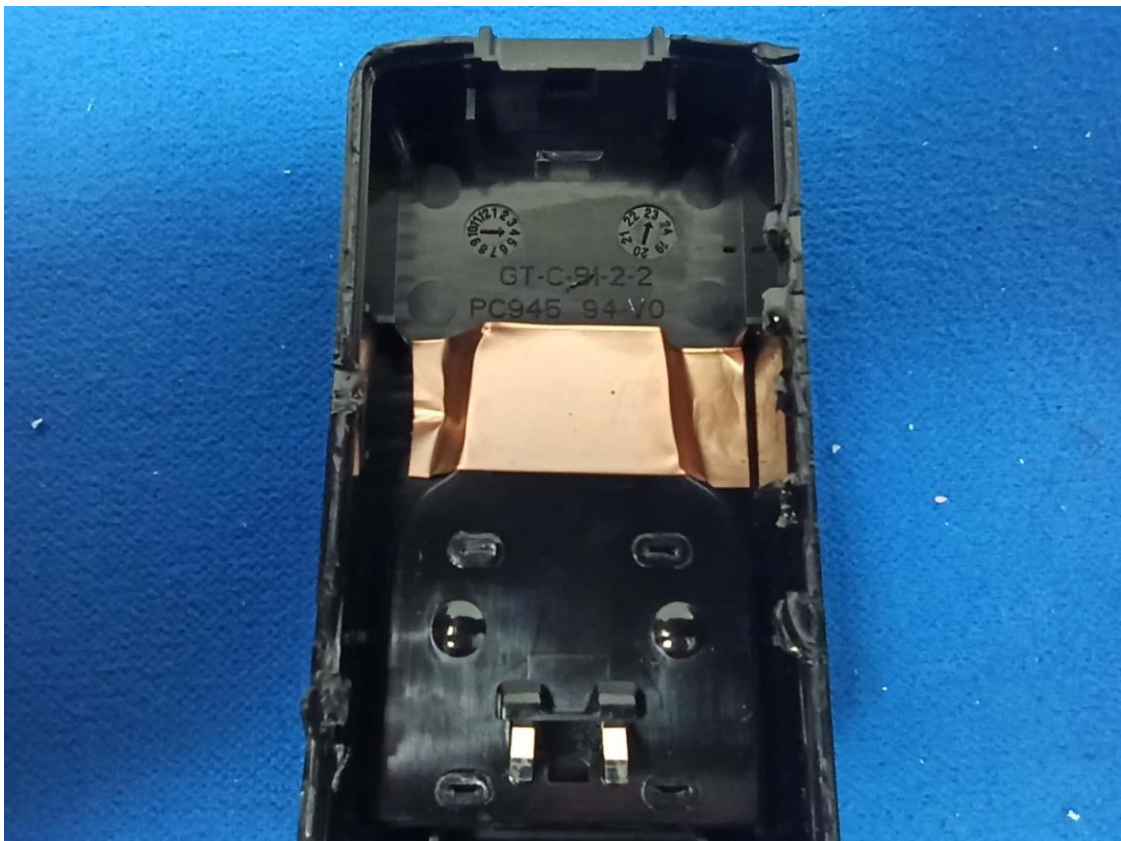



GTM46161-165.5-USB1A1C

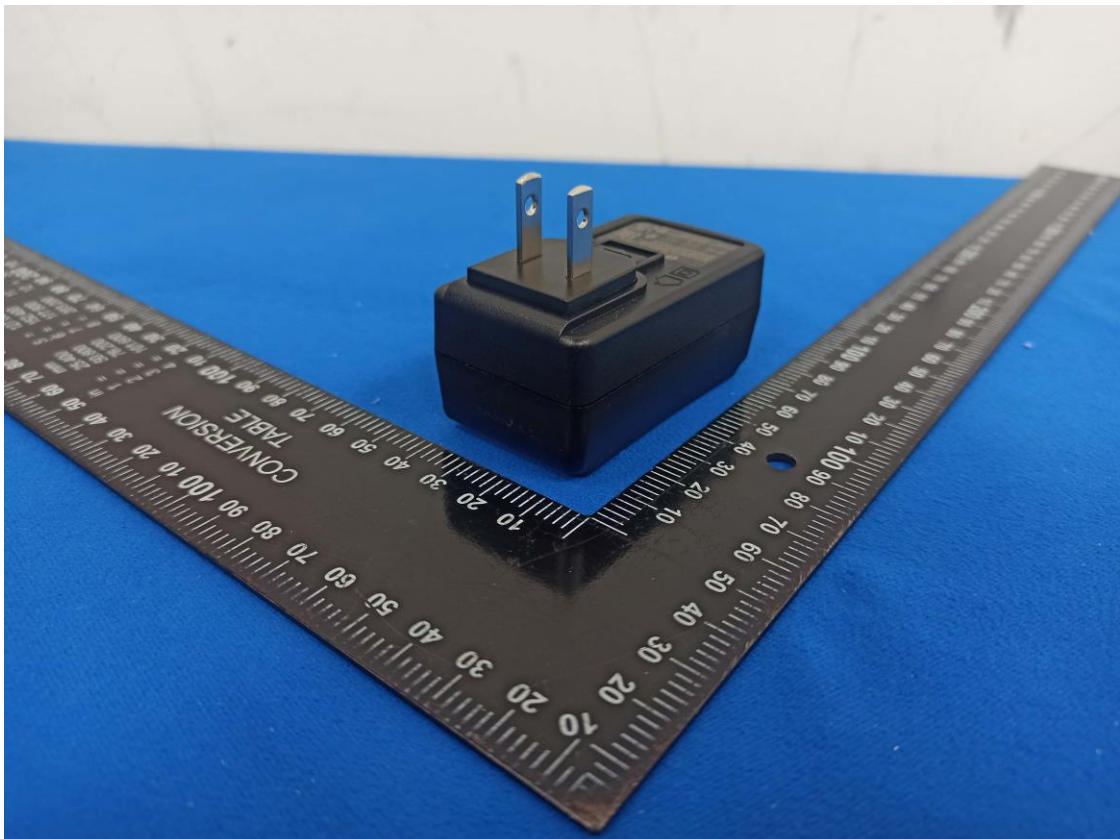
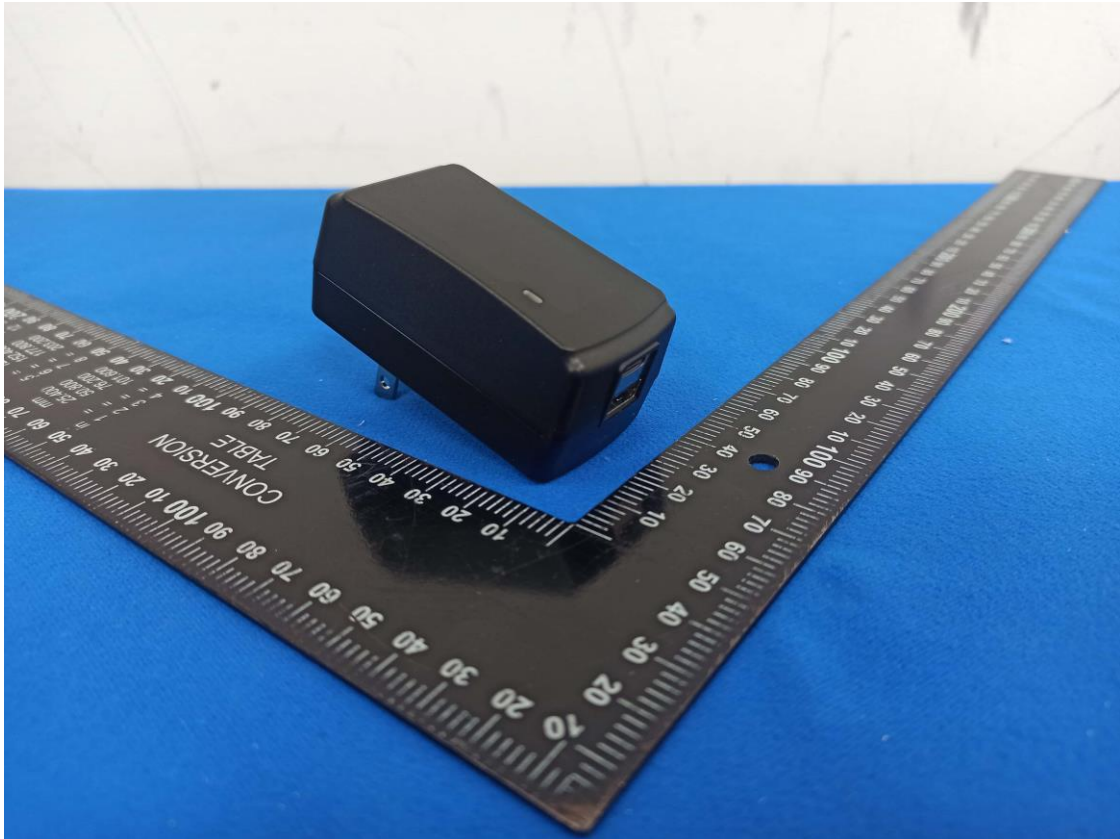





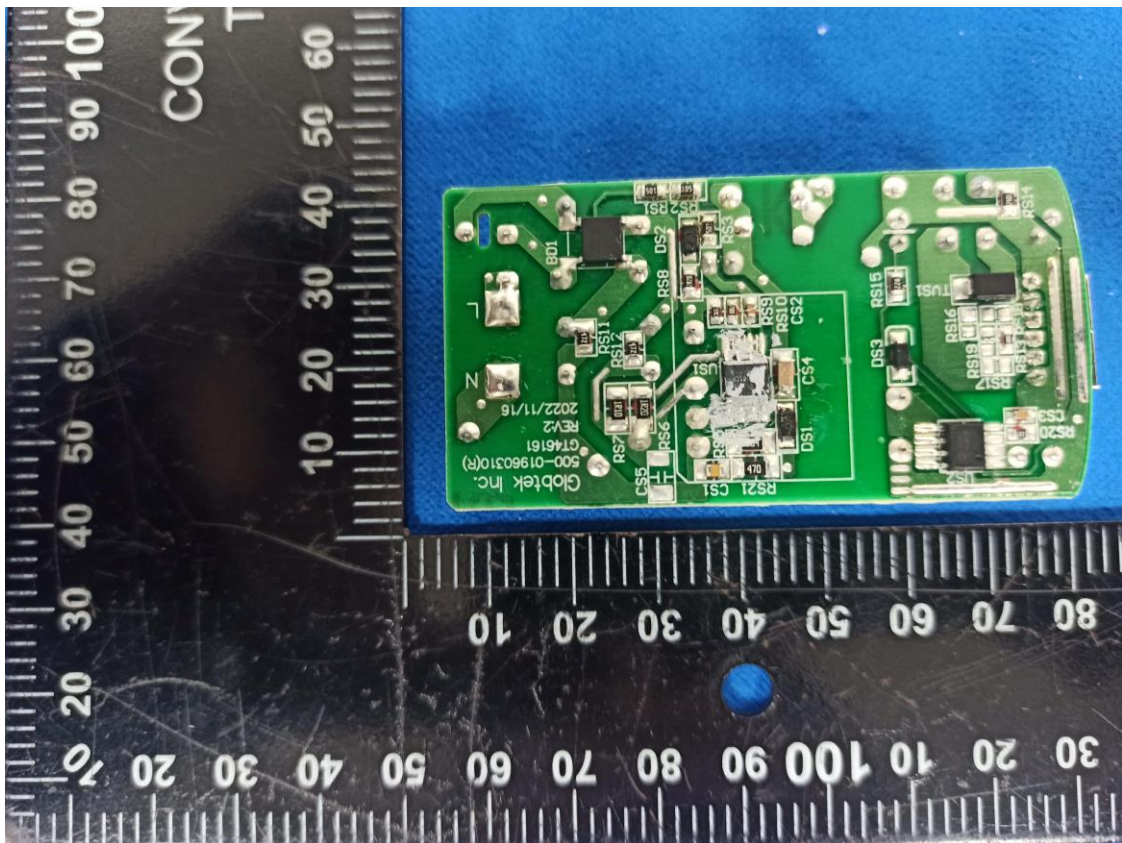
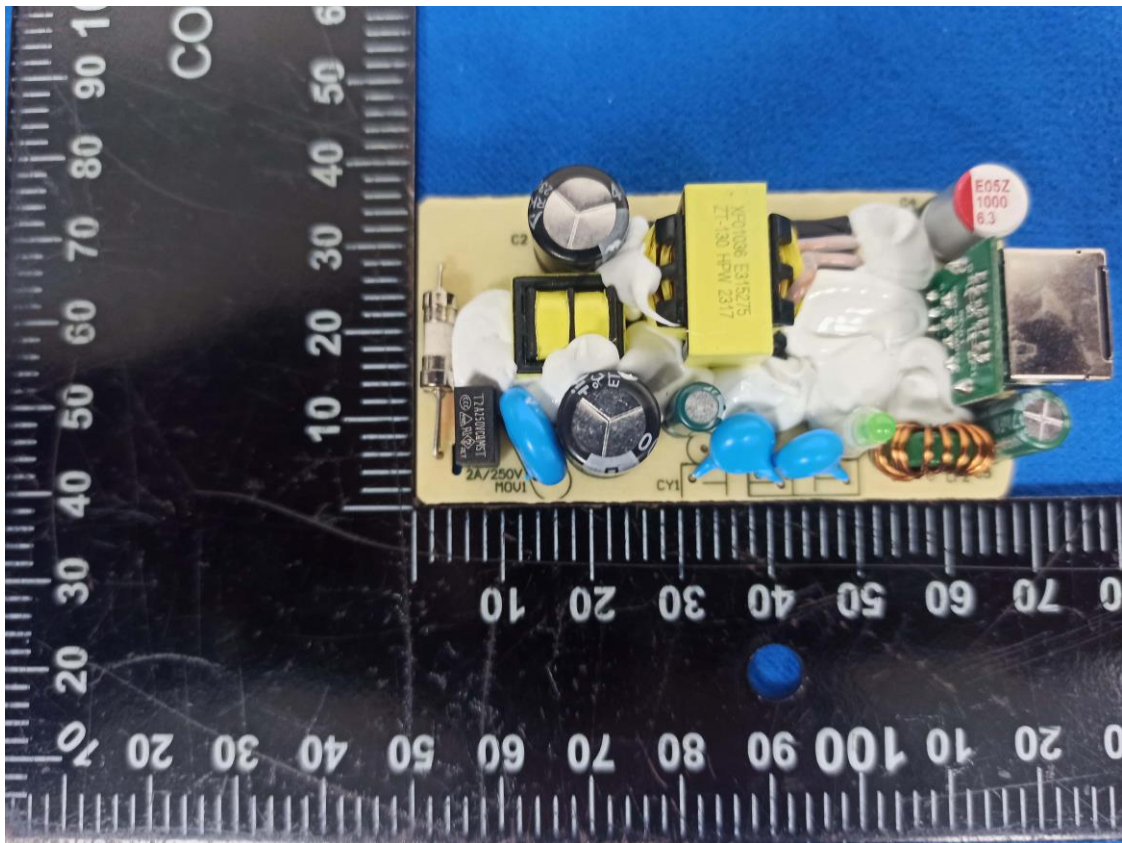





GTM46161-165.5-USB2A

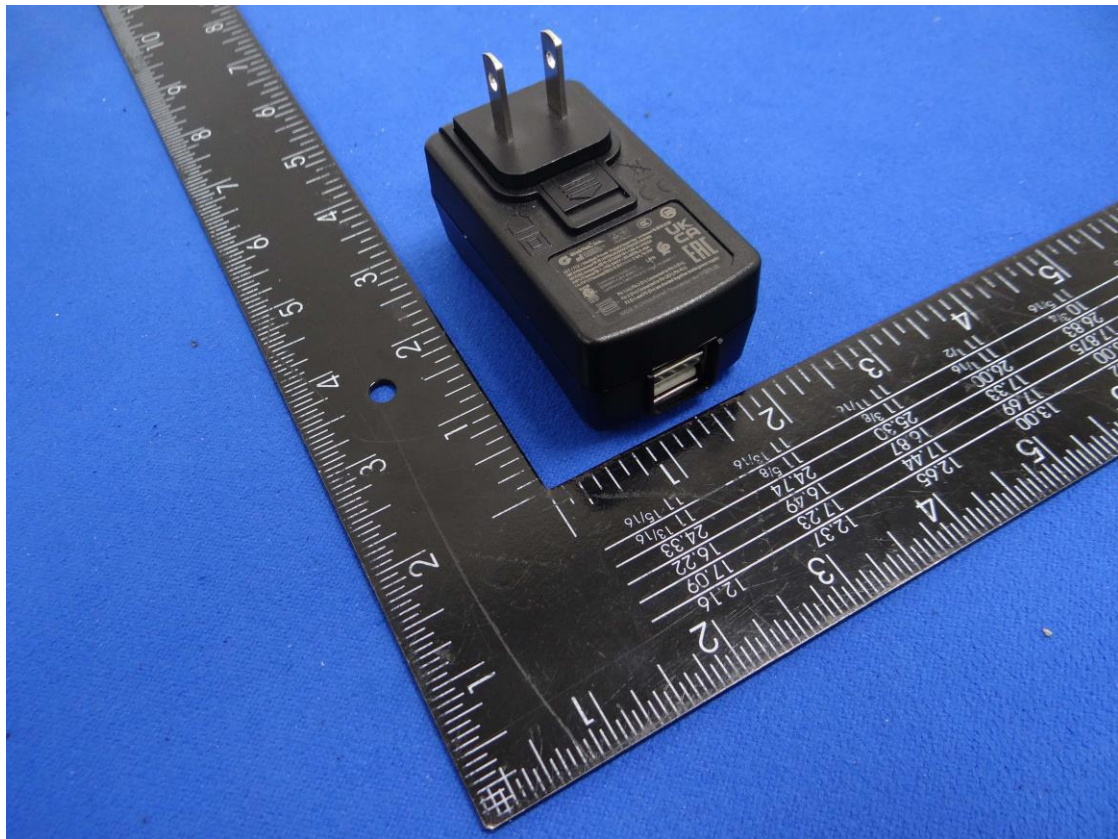
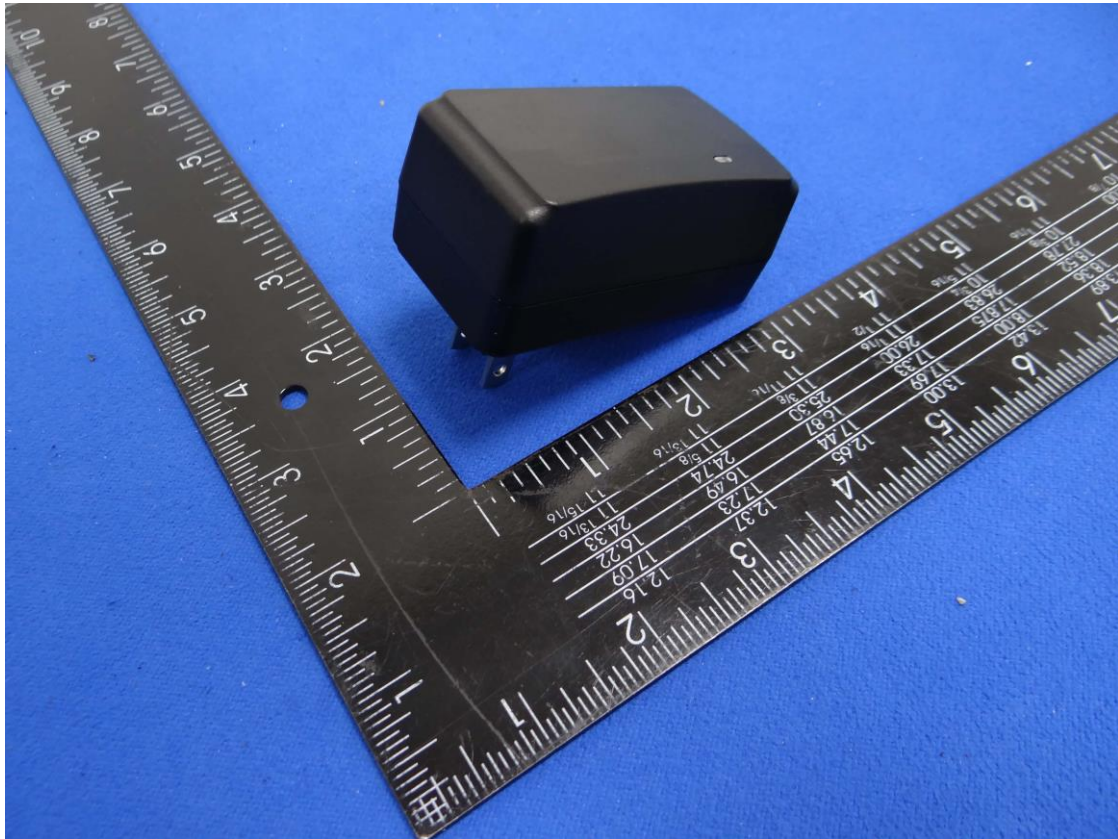



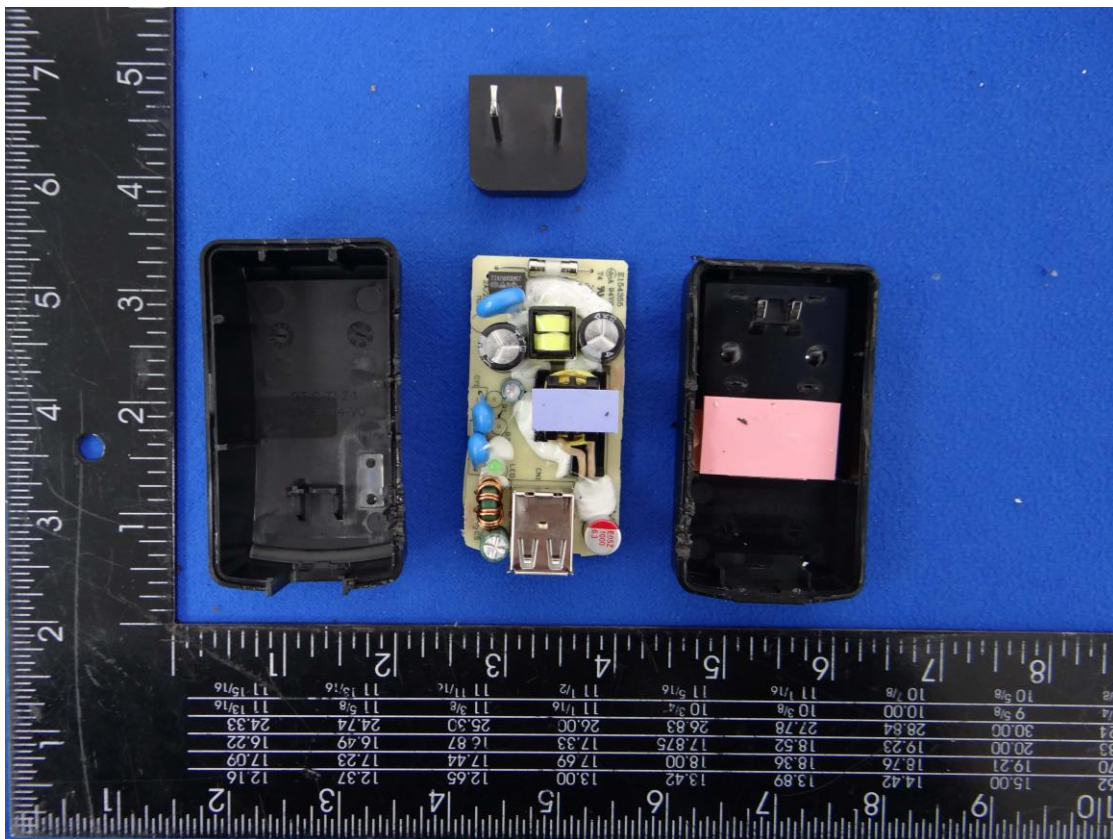

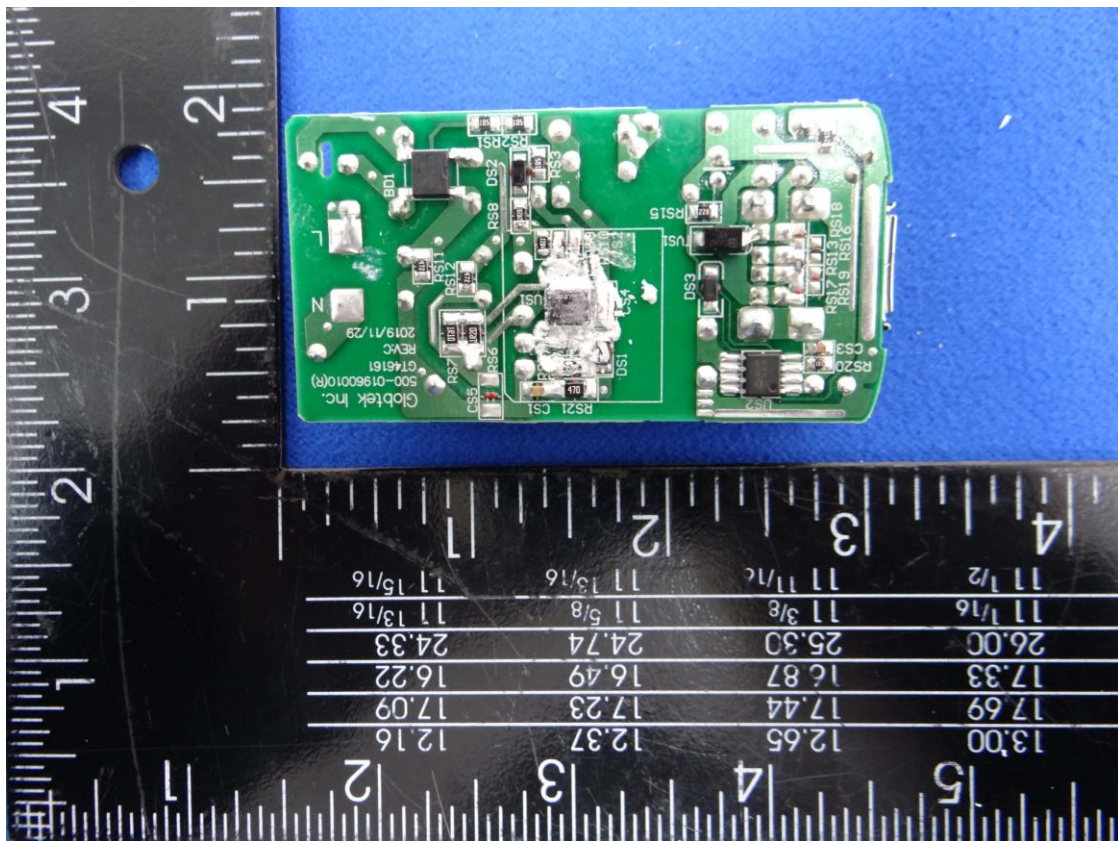
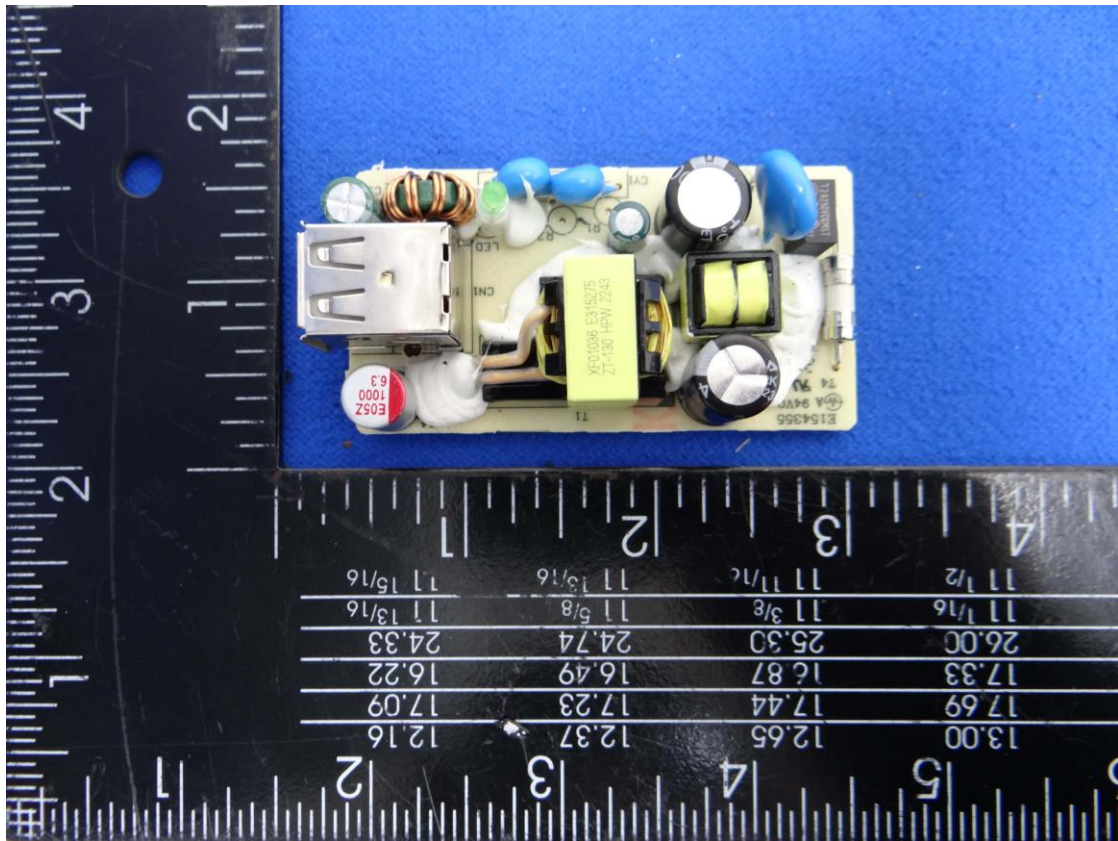

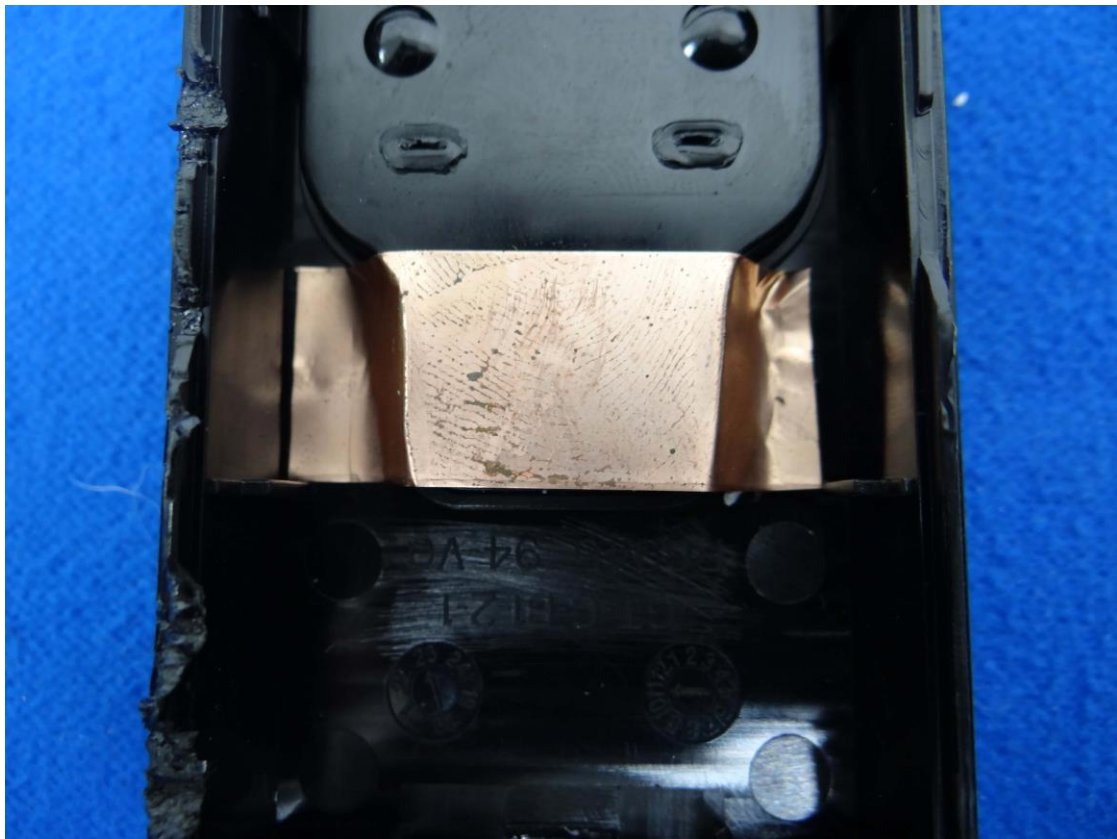



GTM46161-165.5-USB2C

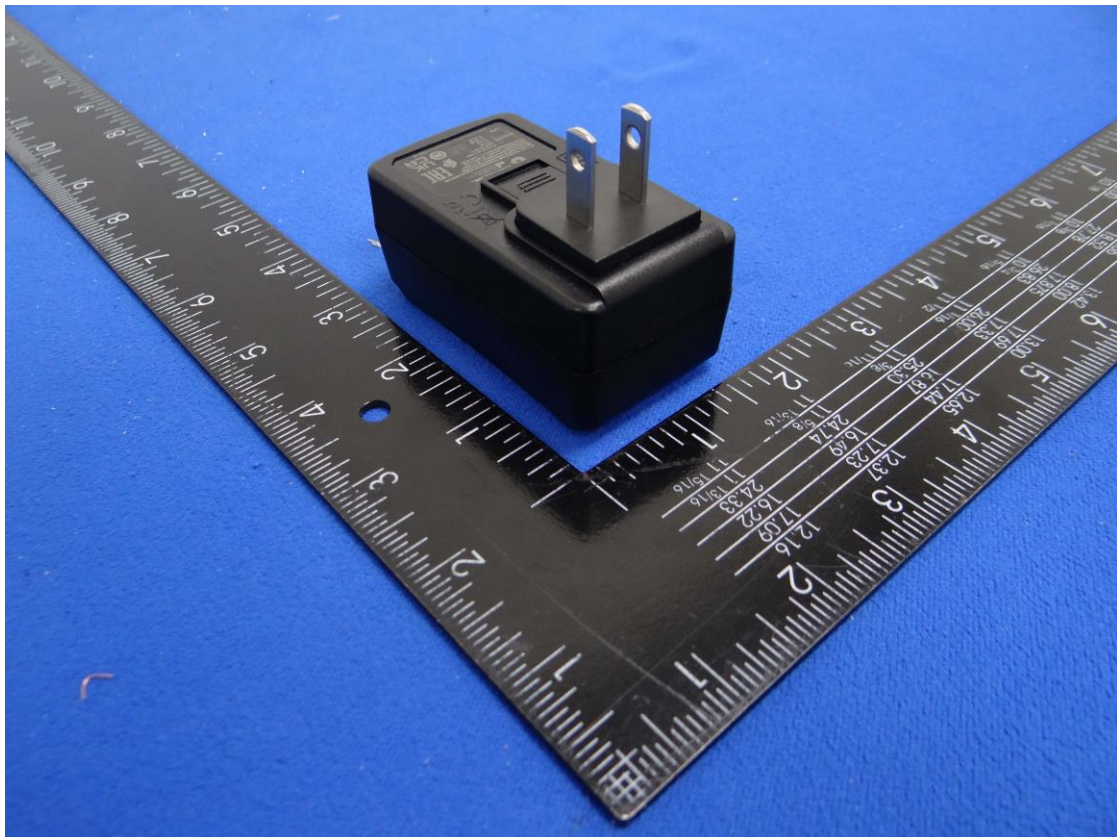
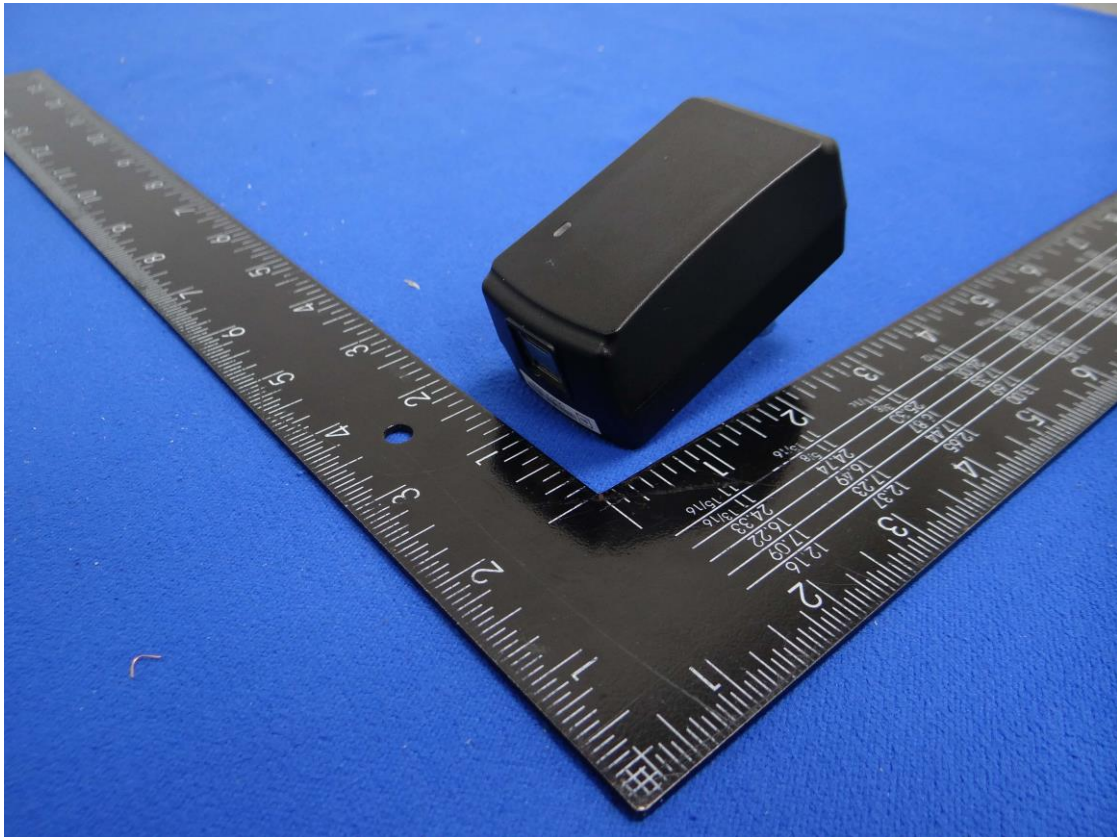





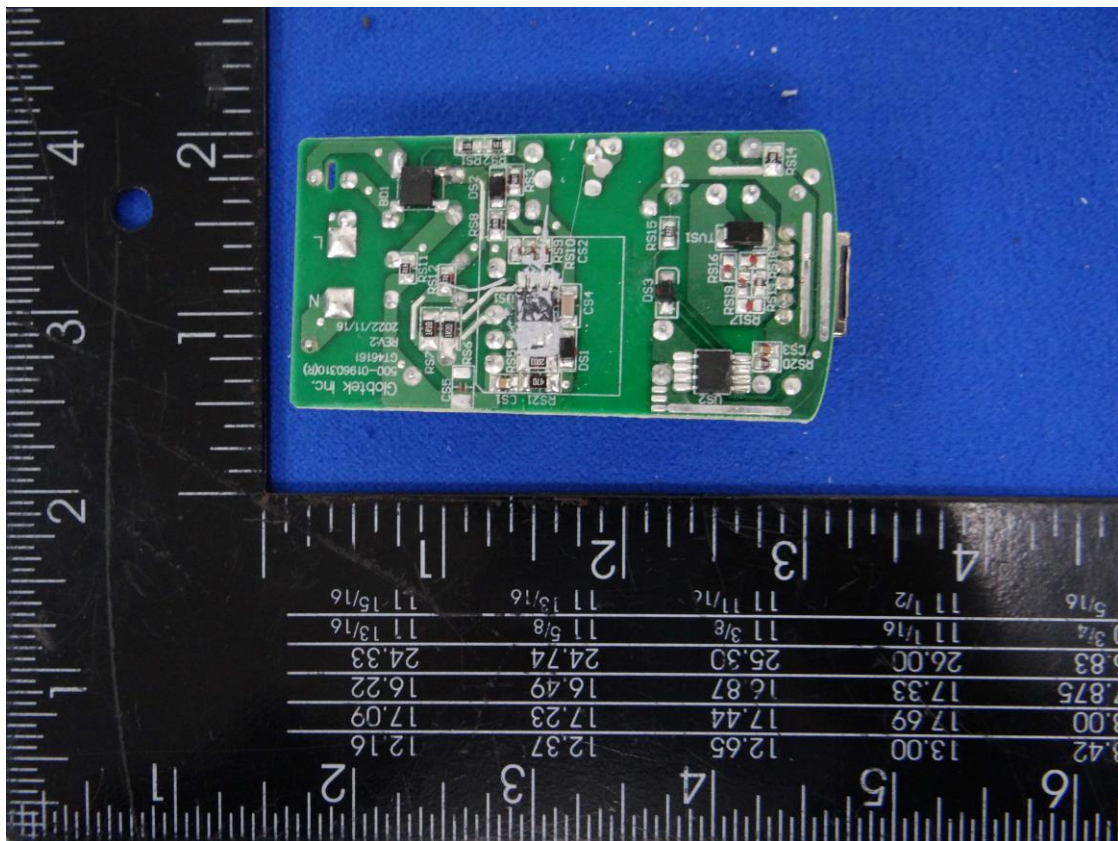
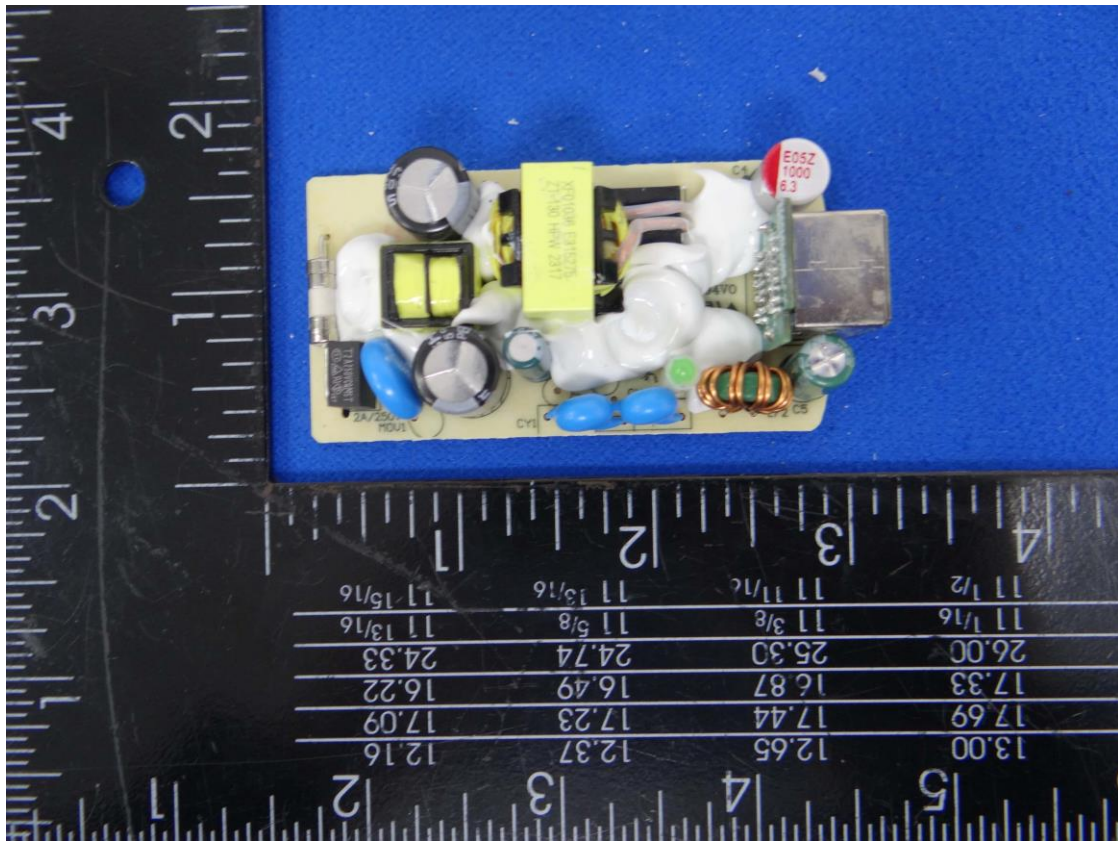

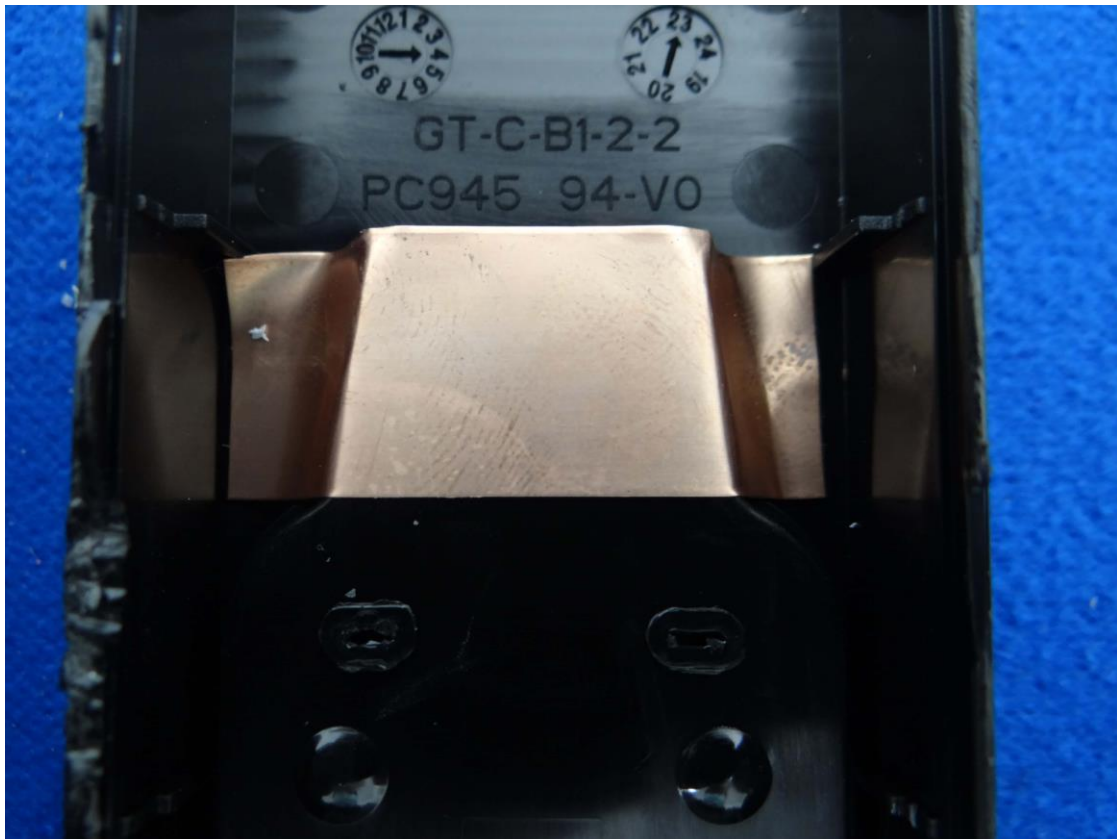



GTM46161-165.5-USBC

